



LANDSCAPE PRODUCTS

2026

www.brickstopedge.com 1.800.565.2599

MISSION STATEMENT

At Brickstop Corporation our goal is to manufacture, distribute and supply our dealer network with the finest quality Paver Edgings and Landscape Accessories, serving the professional landscape contractors' specific needs and requirements.

We strive to provide the best tools possible so you can do the best job possible!

Our customers' needs are our priority. If you can't find a product you require, we are happy to source it for you.

Thank you for your interest in our fine line of superior products.

We're the "good guys to deal with!"

- 02** BEAST Plastic Paver Edging #350 – 8 ft. sections
- 03** Edgeall Low Profile #370 and Simflex Plastic Paver Edging #250
- 04** Brickstop Original L shape Aluminum Paver Edging #150
- 05** L shape Economy Aluminum Paver Edging #170 & Low Profile Aluminum #120
- 06** Edgestar 4” Aluminum Lawn Edging #210
- 07** Spikes, Staples
- 08** Plastic Lawn Edging / Geogrid
- 09** Adhesive - Brickstik XS
- 10** Hardscape / Landscape Fabric
- 11** Hammers
- 12** Block and Paver Splitters
- 13** Block and Paver Splitters
- 14** Levelling Machine and Slab Transporters
- 15** Heavy Lifting Equipment and Sections Clamps
- 16** Block Grab 262150
- 17** Curb Lifting Equipment and Clamps
- 18** Curb Lifting Equipment and Clamps / Tamper Mat Pro
- 19** Paver Hand Tools & Hand Lifters
- 20** Screeding Tools & Rakes, Wall Drains and Ground Drains
- 21** Hand Vacuum Lifter Brushless
- 22** Hand Vacuum Lifter
- 23** High Flow Vacuum Lifter
- 24** Marking Paint / Pallet Wrap / Shims
- 25** Paver Installation Accessories / Gloves / Tarps
- 26** LED Lights - Retaining Wall and Stair Lights
- 27** LED Lights - Recessed Lights and Recessed Stair Light
- 28** LED Lights - Recessed Lights and Spot Light
- 29** LED Lights - Path Lights

B.E.A.S.T. PLASTIC PAVER EDGING #350



**NORTH AMERICA'S
#1
BEST SELLING
PAVER EDGING**

Over thirty years of experience and millions of feet of paver installations have gone into the development of the B.E.A.S.T.

B.E.A.S.T. #350



- Just one piece does both straight lines and curves
- Staggered lattice nailing to ensure maximum hold
- Extra wide base for increased stability
- Easy to install with 10" or 12" nails
- Allows natural vegetation growth
- 100% recycled plastic

Wall: 1.75"
Foot: 3"
Width: 2.5"
Available in 8 ft lengths



STEEL SPIRAL SPIKES #400, #402

Sold in individual 50lb. boxes or by the pallet (48 cases)

10" - approx. 235 Steel spiral spikes

12" - approx. 210 steel spiral spikes

COMMON NAILS #401, #403



See page 07



EDGE-ALL LOW PROFILE PAVER EDGING #370

EDGE-ALL

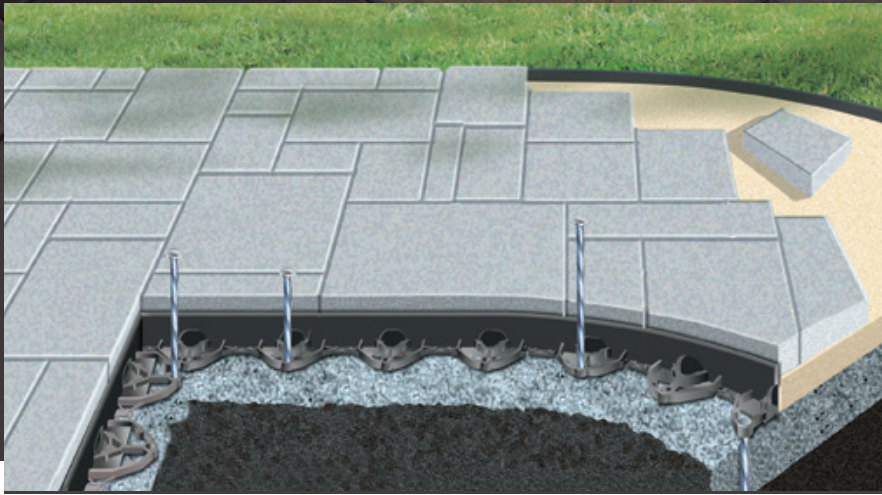

EDGE-ALL #370



- Ideal for thin pavers, wetcast stone, and flagstones
- Super strength
- Super flexibility
- Amazing straight lines
- Perfect curves

Wall: 1.5" Foot: 2.25" Available in convenient 6 ft lengths

STEEL SPIRAL SPIKES #400

Sold in individual 50lb. boxes or by the pallet (48 cases)

10" - approx. 235 Steel spiral spikes

12" - approx. 210 steel spiral spikes

Common nails available



SIMFLEX PLASTIC PAVER EDGING #250

**SIMPLE,
FLEXIBLE,
AFFORDABLE**

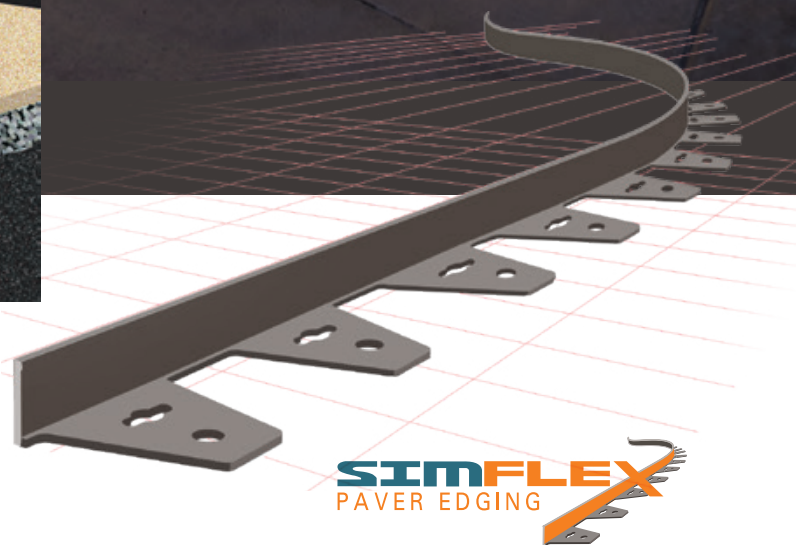

SIMFLEX #250



- Installs easily
- Requires no cutting for curves; suitable for both straight and radius installations
- Ideal for driveways, walkways and patios
- Thick profile manufactured from recycled plastic

Wall: 1.625" Foot: 2.75" Thickness: 0.31" Convenient 7'6" sections

SIMFLEX
PAVER EDGING

ALUMINUM PAVER EDGING #150



**Brickstop
Advantages:**

THE ORIGINAL L-SHAPED PAVER EDGING

Because your reputation is at stake.

BrickStop Aluminum Edging bends to your needs no matter how complex your interlocking brick and paving stone design. Made of aluminum, it's strong enough for straight lines, yet flexible enough to follow the most intricate curved patterns, with optional installation of pavers on either side of the edging.

BrickStop Aluminum Edging prevents the shifting and movement of pavers that could turn your project into an eyesore. BrickStop comes through with a patented design that lets you form 90 degree angles without cutting. Its quick "either side" installation helps bring labour costs down and creates the long lasting results that will keep customer referrals coming year after year.

- Convenient 8'4" lengths
- Made of non-rusting recycled aluminum
- Allows installation of pavers on either side of edging
- Completely hidden from view
- One piece for straight or curved patterns
- 90 degree angles without cutting
- Will not warp in heat or crack in cold
- No loss of material due to overlap at joints
- Includes plastic joiner tab



ORIGINAL #150

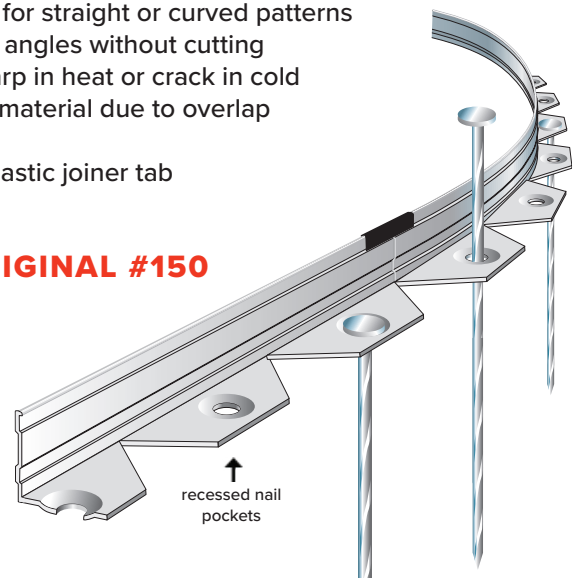

STEEL SPIRAL SPIKES #400, #402

Sold in individual 50lb. boxes
or by the pallet (48 cases)

10" - approx. 235 Steel spiral spikes

12" - approx. 210 steel spiral spikes

COMMON NAILS #401, #403



See page 07

Length: 8'4" (2.54m)

Height: 1.5" (35mm)

Thickness: 0.125" (3.2mm)

Flange: 1.5" x 4" (35mm x 102mm)

Alloy: 6063 aluminum

T-5 hardness

US Patent

ALUMINUM PAVER EDGING #170



#170 - THE ECONOMY L-SHAPED PAVER EDGING

An economical option to our original #150 Paver Edging, with all the same attributes that aluminum paver edging offers.

Allows installation of pavers on either side of edging.

Length: 8'4" (2.54m)
Height: 1.5" (35mm)
Thickness: 0.105" (2.67mm)
Flange: 1.45" x 4" (34mm x 102mm)
Alloy 6063 Aluminum
t-5 Hardness

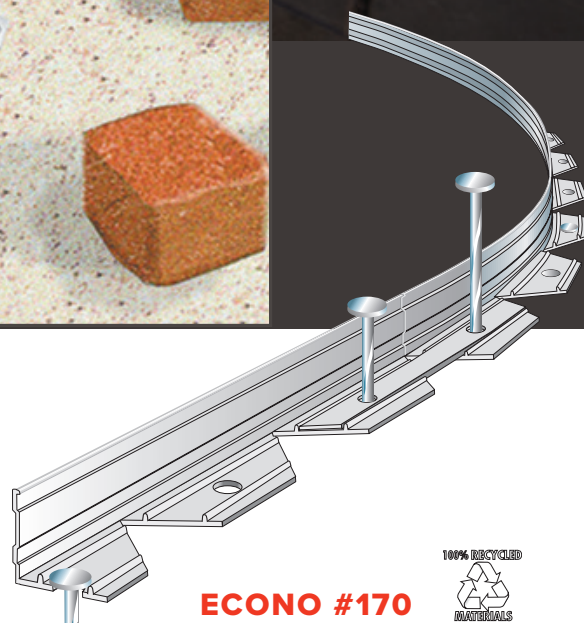

LOW PROFILE ALUMINUM EDGING #120

Brickstop's Lowest Profile Aluminum Edging is ideal for use with 20mm porcelain pavers, flagstone, wetcast shapes and bluestone. Our aluminum edging bends to your needs no matter how complex your design requirements. Made of aluminum, it's strong enough for straight lines, yet flexible enough to follow the most intricate curved patterns.

LOW-PROFILE ALUMINUM EDGING #120

- Convenient 8' lengths
- Made of non-rusting recycled aluminum
- Allows installation of pavers on either side of edging.
- Completely hidden from view
- One piece for straight or curved patterns
- 90 degree angles without cutting
- Will not warp in heat or crack in cold
- No loss of material due to overlap at joints



Length: 8'4" (2.54m)
Height: 5/8" (17mm)
Thickness: 0.125" (3.2mm)
Flange: 1.5" x 4" (35mm x 102mm)
Alloy: 6063 aluminum
T-5 hardness

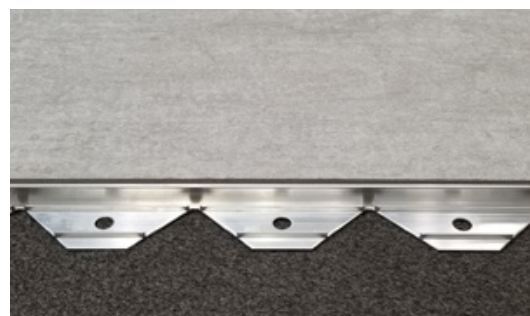



Sizes: 1/8" by 4" (3.2mm by 100mm)
residential/commercial

Finishes: Mill finish; natural aluminum or
black anodized

Length: 8'0" (2.44M) sections – nail every 23"

Nails: 10" by 3/8" spiral steel nails (not included)

Convenient 8' Sections

EDGE STAR ADVANTAGES:

- Keyhole Interlocking System: Lengths are easily and quickly connected.
- Superior Reinforcement – 8' lengths: Rigid enough to provide perfectly straight lines; flexible enough for the most demanding curves.
- No need to use heavier gauge or more costly material to maintain straight runs.
- Heavy duty 1 1/8" nail loops located every 23": allows for more frequent nailing positions, providing superior anchoring where required.
- Steel Nail Anchoring: Spiral 10" nails readily available.

EDGE STAR is produced in 1/8" thickness. Our product's design will maintain straight lines even for the heaviest commercial applications. EDGE STAR is ideally suited for use as a planting bed edging in both residential and commercial applications. Other uses include edging for walkways, jogging trails, running tracks, asphalt borders and maintenance strips.

Available in black anodized.

KEEPS GARDEN BEDS CLEAN AND NEAT!

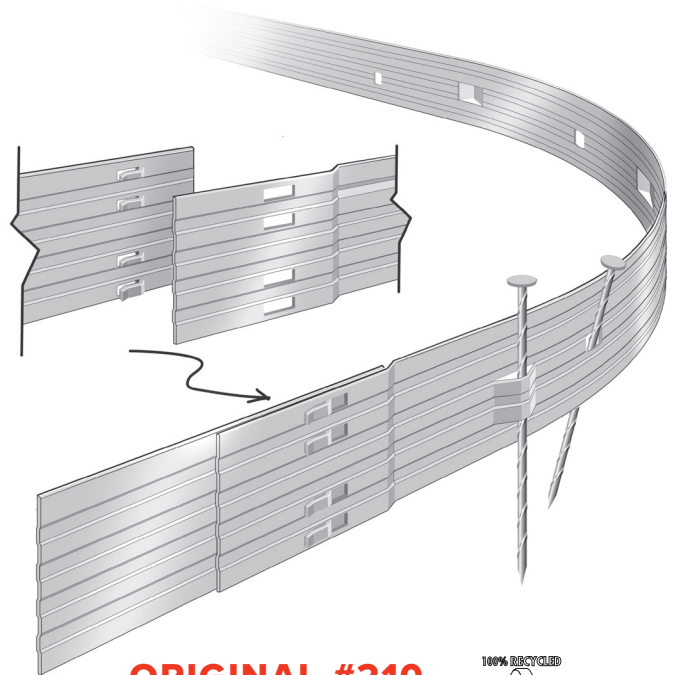

ORIGINAL #210
WITH SNAP-IN
INTERLOCKING TABS



STEEL SPIRAL SPIKES #400, #402

Sold in individual 50lb. boxes
or by the pallet (48 cases)

10" - approx. 235 Steel spiral spikes

12" - approx. 210 steel spiral spikes

COMMON NAILS #401, #403



See page 07

STEEL SPIRAL SPIKES

Sold in individual 50 lb. boxes
or by the pallet (48 boxes)

#400 10" x 3/8" dia. metal bright SPIRAL
approx. 235 steel spiral spikes / box

#402 12" x 3/8" dia. bright spiral
approx. 210 steel spiral spikes / box

#404 8" x 3/8" dia. bright spiral
approx. 265 steel spiral spikes / box

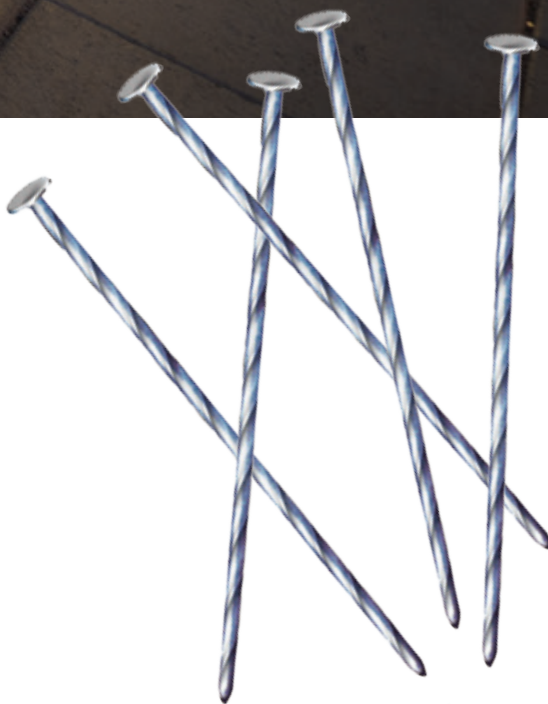

STEEL COMMON SPIKES

Sold in individual 50 lb. boxes
or by the pallet (48 boxes)

#401 10" x 3/8" dia. metal bright COMMON
approx. 155 steel common spikes / box

#403 12" x 3/8" dia. bright common
approx. 125 steel common spikes / box

#405 8" x 3/8" dia. bright common
approx. 175 steel common spikes / box

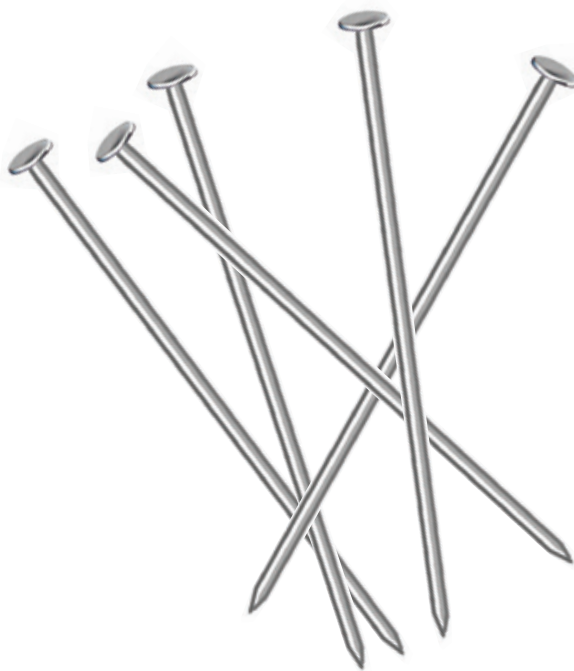

SOD / FABRIC STAPLES

SOD / FABRIC STAPLES

1,000 pieces per box, approx. 34.1 lbs

#407 6" x 1" 11 gauge (2.77 mm/.109")



GREENLINE LAWN/LANDSCAPE EDGING



- Corrugated side wall construction
- Rigid yet flexible, will easily follow the contours of your design
- "T"-shaped base resists frost heave
- Convenient, easy-to-handle 8 foot lengths
- 10 strips per bundle (anchoring stakes, straight or corner connectors sold separately)
- Clean lines provide for ease of installation
- "V"-shaped base resists frost heave
- Convenient, easy-to-handle 8 foot lengths
- Economically priced
- 10 strips per bundle (anchoring stakes, straight or corner connectors sold separately)

PRO-T #240



PRO-V #260

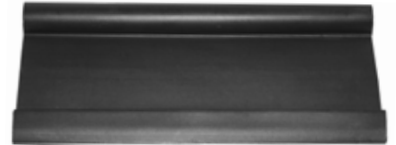

ACCESSORIES

- #261** 9" Galvanized Steel Anchoring Stakes
- #262** 6" Straight Connector
- #263** 90 Degree Corner Connector

GEOGRID RETAINING WALL SYSTEM

- **BG100** BIDIRECTIONAL
4' X 50' DEALER DISPLAY
22 SQ.YDS (12 ROLLS/CS.)
- **BG150** BIDIRECTIONAL
6' X 150', 100 SQ.YDS.
- **BG200** UNIDIRECTIONAL
6' X 300', 200 SQ.YDS.
- **BG350** UNIDIRECTIONAL
6' X 300', 200 SQ.YDS.

OTHER SIZES AVAILABLE UPON REQUEST

Geogrid provides advanced options for dealing with common civil engineering problems and difficult soils. The highest quality for retaining walls, reinforced steep slopes and embankments over soft soils.

Geogrid is constructed of high molecular weight and high tenacity polyester yarns utilizing a complex knitting process and low temperature coating technology to provide superior engineering properties. UV stabilized coating provides further chemical and mechanical benefits.

GEOGRID BY BRICKSTOP IS USED FOR:

- Retaining Walls
- Landscape Repair
- Timber Walls
- Paver Reinforcement
- Steep Slopes



SPECS

Biaxial **LTDS:**
MD 822 lbs/ft
CMD: 882 lbs/ft
Recommended for wall heights up to 6'

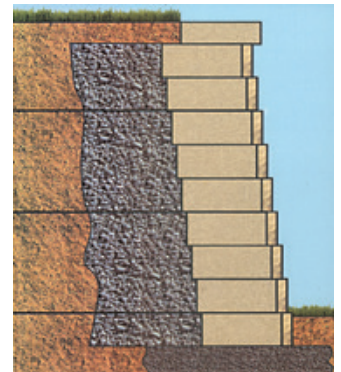



HEAVY DUTY PREMIUM POLYURETHANE FOR CONCRETE AND STONE

Brickstop Brickstik is a one-component premium polyurethane adhesive. Specially formulated to adhere to wet or frozen surfaces. Brickstik is specifically engineered for the Concrete and Paver/Retaining wall industry.

Brickstik is designed to resist water and frost to permanently bond stone, brick, and concrete. Brickstik can be applied in a wide installation temperature span and will not freeze.

FEATURES AND BENEFITS:

- VOC Compliant
- Environmentally sensitive
- Easy gunning – user friendly
- Fast curing – quicker adhesion

#1010 10.5 OZ (313ml), 24/CASE

#1028 29 OZ (858ml), 12/CASE

EXTRA STRENGTH



SUBSTRATE BOND STRENGTH		24 HOURS	7 DAYS:
Concrete to Concrete		300	350
BEAD SIZE IN INCHES (MM)	LINEAL FEET PER 313 ML	LINEAL FEET PER 858 ML	
1/8 (3)	129	353	
3/16 (5)	57	156	
1/4 (6)	32	87	
5/16 (8)	20	54	
3/8 (10)	14	38	



FBR-2006-150

Platinum Woven
3 oz. Fabric Roll, Folded



- 6' x 150' Rolls
- Used for Brick and Block Driveways and many other applications.
- Comes in packs of 12. (Retail Display case)
- Infinite guarantee



Our strongest tensile for the most rugged applications.

- Engineered for hardscape use with Pavers, Driveways, and Patios
- Stabilizes and separates soil profiles, and CONTROLS EROSION
- Ideal for permanent landscape applications - Stops weed growth in all permanent areas around your home
- UV resistant for years of weed control



PAVER MALLET #602-6

13" Handle - 2³/₈" Head, 3.5lbs.

This mallet is made of cast iron and has replaceable inserts. It's perfect for large wall projects. Comes with a life-time warranty.

- INSERTS INCLUDED:**
1. Black Composite Rubber/medium hard
 2. Red Plastic/hard

WALL MALLET #602-8

19" Handle - 3¹/₈" Head 6.6 lbs.

Ideal for retaining wall cap stones. Comes with a life-time warranty.

- INSERTS INCLUDED:**
1. Black Composite Rubber/medium hard
 2. White Nylon/hard

BP PAVER MALLET #696-8

9.5" Handle - 2" Head 3.2 lbs.

This is a soft-face mallet. It is designed with two different inserts of varied hardness. This is a great mallet to use for small adjustments without damaging your products. Comes with a life-time warranty.

- INSERTS INCLUDED:**
1. White Nylon/hard
 2. Red Plastic/hard



DEAD BLOW (40MM) #636-4 14" Handle - 4" Head, 1.6 lbs.

DEAD BLOW (70MM) #636-7 14¹/₂" Handle - 4¹/₂" Head, 5 lbs.

This dead-blow mallet has a steel head with replaceable nylon inserts. A sealed container, within the insert, is filled with a steel shot for a rebound-free strike. Comes with a life-time warranty.

- INSERTS INCLUDED:** 1. White Nylon / hard



SLEDGE MALLET #602-7

31" Handle - 3¹/₈" Head 7.4 lbs.

This sledge mallet is the perfect tool for damage-free, major adjustments. Comes with a life-time warranty.

- INSERTS INCLUDED:**
1. Black Composite Rubber / medium hard
 2. White Superplastic/medium hard

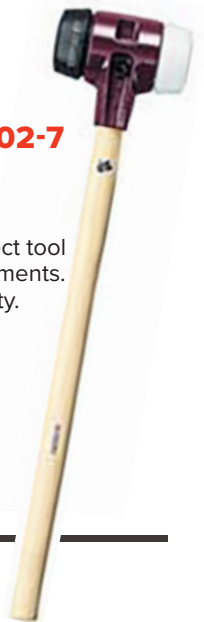

REPLACEMENT INSERTS



WHITE NYLON

- For item #602-8 use insert #620-88
- For item #636-4 use insert #650-84
- For item #636-7 use insert #650-87
- For item #696-8 use insert #698-85



RED PLASTIC

- For item #602-6 use insert #620-66
- For item #696-8 use insert #696-65



WHITE SUPERPLASTIC

- For item #602-7 use insert #620-78



BLACK COMPOSITE RUBBER

- For item #602-6 use insert #620-26
- For item #602-7 use insert #620-28
- For item #602-8 use insert #620-28



PAVER PERSUADER #503

New galvanized steel 36" handle, 8 lbs.



DOUBLE HEADED PAVER MALLET #412

Galvanized Steel 15" Handle Flat Head, weight: 5.5 lbs



GUMMY MALLET #601

32 oz, made in Italy



CLUB HAMMER #602

2.5 lbs. with fiberglass handle, case of 6



RUBBER MALLET #603

32 oz, Case of 24



DEAD BLOW #605

4 lbs, case of 12



MASON HAMMER #607

24 oz. with fiberglass handle, case of 6



BLOCK & PAVER SPLITTER #FBS40

Designed for splitting: • Retaining Wall • Cap Stone
• Rough Cut Face Stone • Paving Stones
• Most flat stone materials on the market today

Tough metal hubcap and rubber wheels.

Spring loaded tray for angled “undercuts” when cutting pavers.

Easy one dial system: (unlike two dials) for perfect cuts every time (No need to set screw every time when cutting same size stone).

GREAT CUTTING RANGE:

- Cutting Width: 16”**
- Cutting Height: 8.3”**
- Weight: 135 LBS.**



HYDRAULIC BLOCK AND BRICK SPLITTER #FBS60

Designed for splitting: • Retaining Wall • Cap Stone
• Rough Cut Face Stone • Granite • Paving Stones - and most other flat stone materials on the market today
• 10 ton jack with 20 ton cutting force

Spring loaded tray for angled “undercuts” when cutting pavers

Adjustable blade height: for all ‘flat faced’ products up to 235 mm

Heavy weight construction: takes a lot of abuse

Reversible blades: with 3 cutting edges



- Cutting Width: 25.6”**
- Cutting Height: 9.25”**
- Length: 28.74”**
- Width: 32.28”**
- Height: 40.95”**
- Weight: 218.26 lbs**



BLOCK & PAVER SPLITTER

#BSN-006

- Fixed hardened galvanized knife, 4 edges
- Spring loaded with plate holder for stone
- Spring Loaded Cut
- 2 spindles to adjust height



GREAT CUTTING RANGE
 Cutting Width - 13"
 Cutting Height: - 1/2" - 6"
 Weight - 80 lbs



BLOCK & PAVER SPLITTER

#BSN-007

- 2 Spindles for height adjustment
- Spring loaded with plate holder for stone
- Galvanized blade
- Powder coated



GREAT CUTTING RANGE:
 Cutting Width: 17"
 Cutting Height: 1/2" – 6"
 Weight: 125 LBS.



BLOCK & PAVER SPLITTER

#BSN-008

- 2 Spindles for height adjustment
- Spring loaded with plate holder for stone
- Galvanized blade
- Powder coated



GREAT CUTTING RANGE:
 Cutting Width: 17"
 Cutting Height: 1/2" – 11.8"
 Weight: 145 LBS.

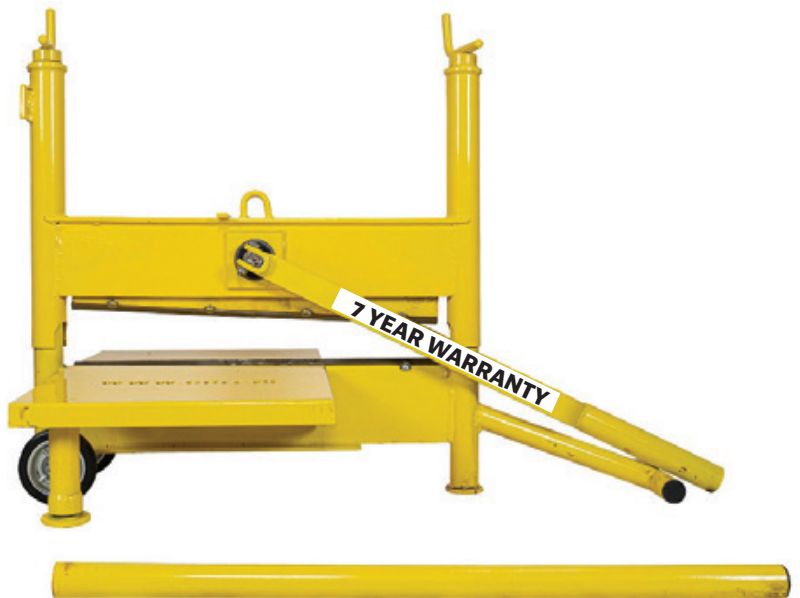

PAVER CUTTER

#MBSN-009

- Powder coated
- Great for small cuts on the go!

Cutting Width: 4.5"
 Cutting Height: 0" – 4.5"
 Weight: 6 LBS.



**SUPER SCREED
LEVELLING MACHINE**

#M-510

Perfect for a quick and accurate screening for pavers
Good for levelling planting beds, gravel and wood chip areas, rooftop beddings

- Minimum width setting 29.2"
- Maximum width setting 48.8"
- Tough powdercoat
- Scraper panel made of non-rusting steel
- Galvanic zinc plating
- Weight 46.3 lbs.
- 9.8" diameter rubber wheel, height adjustable
- Dimensions: 28.8" x 19.7" x 15.8"



7 YEARS WARRANTY
*Except Wearing Parts

NEW PRODUCTS

24" SLAB TRANSPORTER / CADDY
#ST-430

Ergonomic design can lay slabs hands free

- Lifts from 11.8" - 23.6"
- Weight 33 lbs.
- Tough powdercoat



7 YEARS WARRANTY
*Except Wearing Parts



39" SLAB TRANSPORTER / CADDY
#ST-530

Ergonomic design can lay slabs hands free

- Lifts from 11.8" - 39"
- Weight 50 lbs.
- Tough powdercoat
- Short arm adjustable from 11.8" to 21.6"
- Long arm adjustable from 23" to 40"

**GREAT FOR
LIFTING LARGE
SLABS**

**EASES THE STRESS
ON YOUR BACK!**



7 YEARS WARRANTY
*Except Wearing Parts





Our clamps are made by BSV in Denmark. They have been making clamps for 110 years and your operators will fight for the truck that's equipped with the BSV.

All clamps protect the product with rubber contact pads for safe and easy loading and offloading. All clamps are gravity controlled – they open when rested and close when lifted.

We can supply custom clamp solutions if you require a clamp or grab not shown. Many other sizes and configurations are available by special order. Be sure to describe your needs to your salesman as not all clamps are suitable for fork-truck use.



CLAMP #BSV 32/38

For moving the heavier stuff. The 32/38 will safely lift loads from 32" to 38" and up to 4070 lbs. This clamp will perform.



SECTIONS CLAMP

#1002

With the versatile lifting range of 9"-42" and a safe working load of 1600 lbs., this clamp is capable of picking up 1-2 sections of pavers at a time. The 1002 is perfect for separating cubes of pavers and handling materials on site. Fork Yoke Attachment available. **Made in Canada.**

SCISSOR CLAMP

#BSV MULTI 760/50Z



The width of this clamp can be adjusted from 15.75" to 42". A maximum safe working load of 3,300 lbs, the scissor clamp is extremely versatile and ideal for heavy-duty multi-purpose use. Pictured with optional fork yoke.



PALLET FORK WITH BOW

#PG 100

The bow allows for deliveries on uneven ground.

Pallet forks are also available as self balancing with a spring loaded head. Ask your salesman for the model which best suits your needs.



BSV scissor grab type #262150 is the easy solution for lifting and moving concrete Lego block elements.

- The grab has an **automatic locking system**, which means that it grips every second time and releases every second time when operated by the crane operator.
- It is also **mounted with a restricter bar** to prevent clamping and personal injury.
- The span of the grab is **400-800 mm (15 ¾" - 31 ½")** and it can lift up to **2,500 kg (5500 lbs)**.
- All our grabs are 100% made at the BSV factory in Denmark and are proof-loaded at our testing branch and **supplied with test certificates**.
- BSV keeps original **spare parts in stock**.
- Designed for moving and stacking Ecology Block and Lego Block.

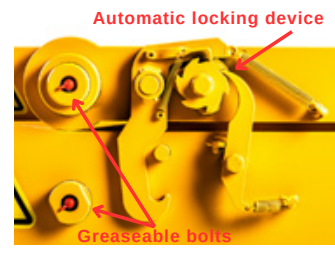
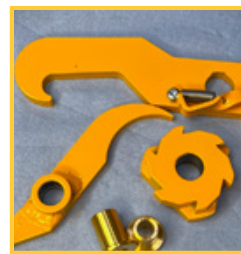



TREADSETTER
#600T/1200T

Eliminate finger smashing, back breaking, time consuming and work-related injuries using the new TREADSETTER. The Treadsetter is designed to handle various step treads from 12"–35" in depth – up to 4" in width and with a 6"–8" rise. This new product is easily adjusted to tread width and balance. The tool has pivot-style urethane ends to reduce slippage and protect the stone, as well as servicing other applications in various weather conditions. Ideal for Rosetta Stone.

TWO SIZE AND WEIGHT CAPACITIES

#600T: 600 lb Treadsetter, 12"–25" in depth

#1200T: 1200 lb Treadsetter, 20"–35" in depth

OCTOPUS LIFTING CURB CLAMP

#RT101

Suitable for handling steps, curbs, L-stones, etc. with a lifting device. Easily adjustable quick spring bolt opening. Curved curb stones are also gripped securely, as the gripper has an inside height of 7" enabling grip from underneath. Automatically opens upon release.

- Weight: 73 lbs
- Clamping depth: 7.4"
- Max. load: 1322 lbs
- Min. width setting: 1.9"

- Max. width setting: 23.5"
- Surface Treatment: Powder Coated Yellow
- Product dimensions: 26" x 23" x 33"



SCISSOR CLAMP MODEL

#10-38

A lightweight clamp suitable for lifting curbs and other narrow stones. Lifts from 4" to 15" at a maximum safe working load of 1540 lbs.

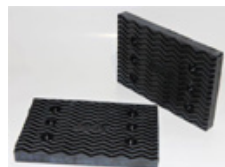

JED CLAMP IT / TREAD/CURB CLAMP

- #J900** 4" - 22" max width 900lbs
- #J2400** 8" - 32" max width 2400lbs
- #J3000** 12" - 42" max width 3000lbs



MONTOLIT CURB CLAMP

#A016 (R)

Mechanical or hand-lifter. 3.15"-7" 440lb capacity

CURB LIFTING EQUIPMENT & CLAMPS



EASY GRIP LIFTING CLAMP #RT202

Ideal for handling stone with flat surfaces. Attachable to loading crane, mini-excavator/skid. Steer to allow one person to guide for precise placement. Two handles also allowing for a two-man manual operation.

- Range - 1/2" - 16.5"
- Weight - 28 lbs
- Depth - 5.5
- Max Load 1200 lbs.

TAMPER MAT PRO



TAMPER MAT PRO #510

High-Modulus Polyethylene Thermoplastic

- Attaches to many different plate compactors with its universal size of 19" wide x 24" long x 0.25" thick. Flexible front lip.
- Matt includes 1 pair universal aluminum mounting brackets.
- May be cut down to small sizes

- Quick attachment at any point during a project without slowing down the job.
- Keeps the travel speed and compaction force you need when making that critical final pass over the pavers and poly sand.
- Lasts a long time – high abrasion resistance and low coefficient of friction.



PAVER EXTRACTOR GALVANIZED

#502N

Adjustable: 7.8"-11.8"
Weight: 10 lbs



PAVER-PRY #504

The ideal tool for positioning pavers and checking joints.

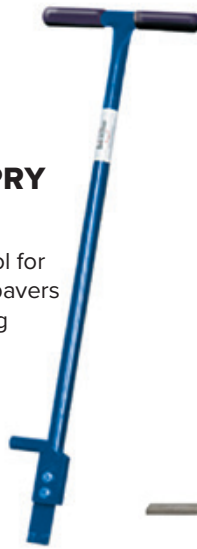

12" SLAB LIFTER

#506

- Lifts from 4" - 12.75"
- 2 spring steel teeth included
- Galvanized steel
- Replaceable teeth



2 MAN CURB LIFTER #2CL425

- Range 19.5"-43"
- Max weight 330 lbs
- Detachable for bobcat / Skid Steer
- Galvanized, non rusting
- Weight 25 lbs



TWO MAN CURB STONE LIFTER #2CL525

- Range - 1/2" - 11.5"
- Depth - 8.25"
- Max weight 440 lbs
- Weight - 26 lbs
- Galvanized - non rusting



20" BLOCK/PAVER LIFTER

#M-002

- Lifts from 11.4" - 20.8"
- Lifts up to 50 lbs.
- Tough powdercoat



24" GIANT SLAB LIFTER

#M-003

- Lifts from 7.9" - 24"
- Lifts up to 130 lbs.
- Galvanized steel
- Ergonomic design

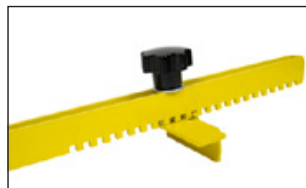
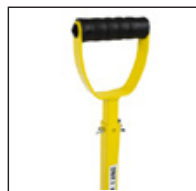

SCREEDING TOOLS & GRADING RAKES

ALUMINUM SCREED BAR

Lightweight, hollow. 1" x 4". Lengths: 4', 6', 8'.

#509-4 - 4FT

#509-8 - 8FT



ALUMINUM SCREED RAIL #508

Helps set levels. Lightweight. 1" x 8'.

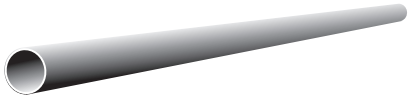

LANDSCAPE/ GRADING RAKE

The strongest aluminum rake money can buy! All-aluminum construction – lightweight, 5.5 lbs. (36" and 48")

Extra thick tines, up to 50% more material and an extended striking

edge to reduce dirt buildup. 66" aluminum alloy handle is powder-coated to eliminate blackened hands. Head connection is secured with a solid aluminum plug for maximum strength. Wrap-around bracing.

WALL DRAINS & GROUND DRAINS

CHOOSE YOUR COLOUR



grey

tan

black

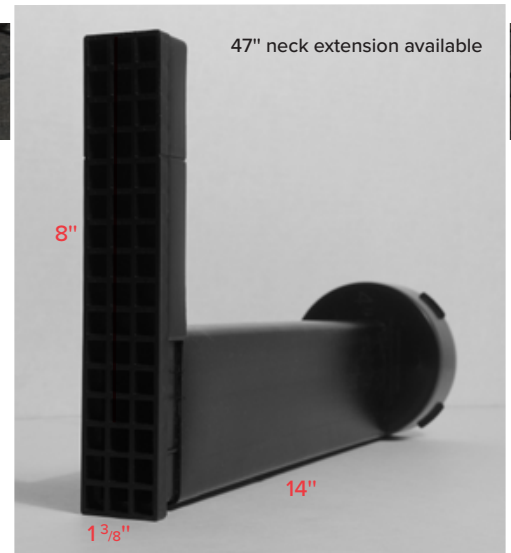

UNIVERSAL WALL DRAIN PRO

#WDP03/WDP04

- designed for all 3"-8" block easy installation
- aesthetically pleasing
- reduced labour costs
- height easily modified for use with any size block or timber

#WDP03

- male end snaps into 3" piping

#WDP04

- male end snaps into 4" piping



DRAINAGE KIT #PC100A

This is ideal for below grade driveways.

DRAINAGE KIT INCLUDES:

- 3 drains (39" each)
- 3 stainless steel grates
- 1 solid end cap (#DN75)



REPLACEMENT CLIP #PC100C

(FOR #PC100A)

END CAP FOR 4" PIPE
#PC100B



SOLID END CAP
#DN75

(FOR #PC100A)



GRABO Pro Brushless



LIFTS EXTREMELY POROUS HEAVY MATERIALS



GRABO Pro Brushless #555

The Ultimate Intelligent Vacuum Lifter

The all-new GRABO® PRO BRUSHLESS is GRABO's most advanced and intelligent vacuum lifter. It features a robust, energy-efficient brushless motor, part of the new **20V battery** platform (18V in the EU), and comes standard with a **2.5Ah battery**. This powerful motor delivers a rapid airflow of **30 liters per minute**, achieving a **full vacuum in just 5 seconds**.



Key Features for Precision and Control:

Adjustable Suction: A built-in vacuum limit selector, easily managed via the large LED digital display, allows users to manually set the suction limit. This is ideal for handling delicate materials, such as thin glass, without the risk of over-suction or damage.

Ergonomic Design: Designed for superior comfort and control, this product features a rubberized slim handle and provides instant feedback through its easy-to-read LED screen.

Remote Operation: The included and built-in wireless remote control enables convenient operation from up to 30 meters.

Maximum Versatility: It boasts a maximum lifting capacity of 375 lbs (170 kg) and is fully compatible with existing GRABO® attachments and accessories, maintaining the trusted seal size and anchor points of previous models for maximum job site versatility.

Dimensions	310x191x149 mm / 12.2x7.5x5.9 inches
Net weight (with battery)	2 kg / 4.4 lbs

LIFTING FORCE CHART:		
	Perpendicular holding force	Parallel holding force
Metal	165kg / 363 lbs	110kg / 242 lbs
Wood	163kg / 359 lbs	65kg / 143 lbs
Glass	170kg / 375 lbs	120kg / 265 lbs
Rough Slate	169kg / 372 lbs	80kg / 176 lbs
Plastic	129kg / 284 lbs	100kg / 220 lbs
Ceramic Tile	170kg / 375 lbs	120kg / 265 lbs
Rough Concrete	156kg / 344 lbs	80kg / 176 lbs
Drywall	100kg / 220 lbs	65kg / 143 lbs



GRABO Pro 2.0

"Heavy Lifting Made Easy"

PORTABLE ELECTRIC VACUUM LIFTER

GRABO PRO-LIFTER 2.0 #530



The GRABO Pro-Lifter is designed for professionals.

The tool is portable and handy. Equally effective on smooth as well as coarse surfaces. Has a pumping capacity of 20 liters per minute, a best in class. Say good-bye to unreliable, and often dangerous, manual suction cups for the job. With GRABO Pro you double your work efficiency with enhanced safety.

Ergonomically designed to provide better grip and less fatigue when moving heavy objects. An effective vacuum lifter even for dusty, semi-porous or rough surfaces. Works perfectly with glass, wood, ceramic tiles, metals and other materials. The powerful vacuum pump and rechargeable battery pack are concealed within the grab handle.

KIT INCLUDES:

GRABO Pro-Lifter comes as a complete unit, with pre-installed battery and vacuum seal.

That is not all. There are other accessories in the kit, including a multi-socket charger and a heavy duty carry bag. The complete kit is packaged in a functionally designed colorful box.

Package Contents:

- 1 GRABO Pro tool (2021 model with digital display)
- 1 multi-socket charge
- 1 seal (preinstalled on the tool)
- 1 battery (preinstalled on the tool)
- 1 tough Oxford fabric carry bag
- Operator's manual in English

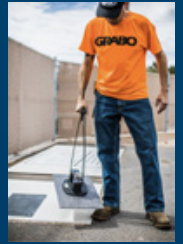

ACCESSORIES

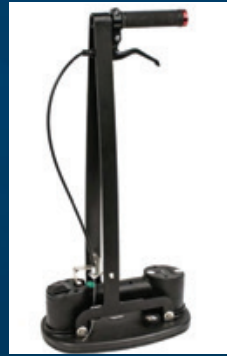

ERGUO S1 portable lifting attachment #525

Reduce work related fatigue or injuries. AVOID an impact on your back from working long days in a bent down position to lift materials.

Operate the GRABO tool without bending. The attachment easily fits into the 4 lifting lugs next to the grab handles of the tool. Simply activate the GRABO tool to lift your material, lift and position the material, and release the tool from the material – in one swift motion without bending down. The actuator on the handle bar helps in controlling the functions. Compatible with all models, except the Grabo H as that is designed for simpler and shorter duration usage.



High-capacity spare battery #523

If you are working in a remote location or need spare batteries, then just order as many from any of our suppliers.

These batteries are as powerful as the ones supplied with the tool. A full battery charge delivers up to 900 operating cycles or 1.5 hours of uninterrupted run time. The high-capacity battery can be used with all models except GRABO H.

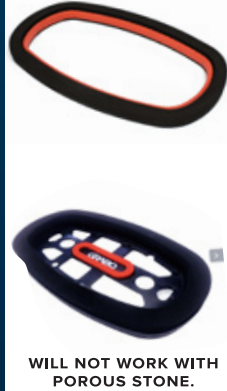

Extra Seals #522

With continuous usages the seals wear out. When the GRABO seal finally wears out, the lifting capacity diminishes. In this case you can replace the worn seal by hand within seconds.



You can use the spare one supplied with the kit. Alternatively you can buy as many from any of the distributors or retailers. This patented high friction foam-rubber seal fits all GRABO models.

RockSeal™ #524 is a new seal system that fits all GRABO models, including Nemo GRABO, GRABO Pro lifter-20, RTC tools GRABO, FXAH-120 Probst GRABO, Topspin Powertools GRABO and other co-branded units.

This patented seal is designed specifically for extremely rough stone & rock surfaces with up to 10 mm surface profile.

WILL NOT WORK WITH POROUS STONE.

GRABO Pro 2.0 Weight lifting safety parameters



Material / Direction	Glass	Ceramic tiles	Metal	Plastic	wood	Rough Slate	Rough Concrete	Dry Wall
 PERPENDICULAR HOLD	375 Lbs (170 kg)	375 Lbs (170 kg)	242 Lbs (110 kg)	220 Lbs (100 kg)	220 Lbs (100 kg)	176 Lbs (80 kg)	176 Lbs (80 kg)	165 Lbs (75 kg)
 PARALLEL HOLD	265 Lbs (120 kg)	265 Lbs (120 kg)	242 Lbs (110 kg)	220 Lbs (100 kg)	143 Lbs (65 kg)	176 Lbs (80 kg)	176 Lbs (80 kg)	143 Lbs (65 kg)



GRABO #520

- KIT INCLUDES:** • 1 - rechargeable battery pack
• Charger • Canvas bag • One foam rubber seal • Filter



Material / Direction	Glass	Ceramic tiles	Metal	Plastic	Wood	Rough Slate	Rough Concrete	Dry Wall
 PERPENDICULAR	375 Lbs	375 Lbs	242 Lbs	220 Lbs	220 Lbs	176 Lbs	176 Lbs	165 Lbs
 PARALLEL	265 Lbs	265 Lbs	242 Lbs	220 Lbs	143 Lbs	176 Lbs	176 Lbs	143 Lbs

GRABO High Flow

LIFTS EXTREMELY POROUS HEAVY MATERIALS



LANDSCAPE PRODUCTS

NEW PRODUCT



Powerful 20 Volt Battery

GRABO High Flow #630

This powerful handheld vacuum tool grips extremely porous stone and heavy materials. Where the GRABO leaves off, the HIGH FLOW picks up. With a vacuum flow rate of 1.5 cubic meters per minute, never before has there been a handheld portable vacuum tool this powerful that grips the most porous materials out there. Features a new pistol grip design. **Easily lift, grip, move, or install heavy and porous materials on the job site with precision and reliability.**



GRABO® High Flow lifting capacity

NOTICE The GRABO® High-Flow was tested up to 57.6 kg (127 lbs) with no suction plate attached, 130 kg (287 lbs) with the 300*300 suction plate, and 256 kg (564 lbs) with the 400*400 suction plate at maximum lifting force under ideal conditions. However, this figure is the breaking point under optimal lab testing conditions and must never be reached in real-world applications!

Specifications:

Model / SKU	GHF-V1
Dimensions	300 x 184 x 148 mm / 11.8 x 7.2 x 5.8 inches
Net Weight (with the 300*300 add-on & battery)	2.8 kg / 6.2 lbs
Rated Air Flow	1500 L/min (1.5m³/min)
Maximum Vacuum Rate	-0.20 Bar (-20 kPa)
Suction Power	80W
Working Temperature	0°- 60°C (32°F - 140°F)

GRABO High Flow kit includes:

- GRABO® High-Flow tool
- Suction plate 300 with SMART CUT foam seal
- Two (2) GRABO HIGH FLOW batteries
- Battery Charger
- T-Bar handle attachment with wired remote control ON/OFF Cable
- Spare SMART CUT foam seal 300
- Extra Filter
- Operator's manual
- HIGH FLOW Canvas Carrying Case
- **Suction Plate 400 available as an add-on, but not included in kit.**

Lifting force chart

PRESSURE VALUE		NO ATTACHMENT		SUCTION PLATE 300		SUCTION PLATE 400	
PSI	BAR	Lbs	Kg	Lbs	Kg	Lbs	Kg
3.0	0.2	75	34	150	68	242	110
2.5	0.17	66	30	134	60.7	220	100
2.0	0.137	50.7	23	108	49	205	93
1.5	0.1	32.4	14.7	73.4	33.3	176	80
1.0	0.06	22	10	50.7	23.3	96	43.5

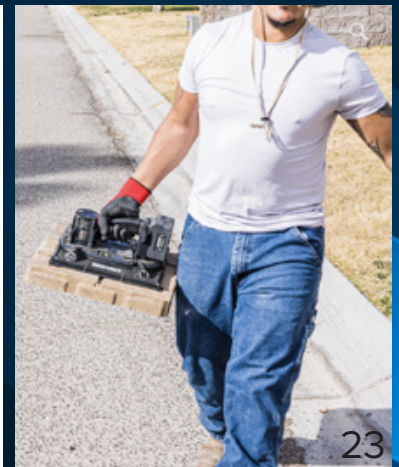

BRICKSTOP INVERTED MARKING PAINT

#550

FEATURES AND BENEFITS:

- Ultra bright
- Inverted tip
- Fast dry – non clogging
- Water based – safe on grass and plants
- Lead free – VOC Compliant
- Colors – Fluorescent Orange, Fluorescent Red, Hot Pink, White
- 12 – 482 gr. cans/cas
- 17 oz.



PALLET WRAP (CAST)

#PW-001

Stronger and has more stretch than blown, use less wrap per pallet.

- Ideal for Stoneyard material
- Durable film resists punctures for increased load retention
- Clear film to keep your wrapped products visible
- Cast hand wrap, 2-sided cling
- 15" x 1500" x 80 guage
- 4 Rolls per case
- 48 Cases per pallet



EZ-SHIM™ #512

THE ALL PLASTIC LOAD BEARING SHIM



FEATURES AND BENEFITS:

- LOAD BEARING up to 8,000 psi • WEATHERPROOF
- Easy break off points • Handles big nails and screws
- Injection molded into sheets of ten / 36 sheets per case



LOAD TESTED

Compression (downward force) until deflection. Results measured in psi (avg.)

		HEEL	MID	TOE
EZ-SHIM		8,029 psi	7,993 psi	7,947 psi
CEDAR		1,367 psi	1,711 psi	5,370 psi
PINE		1,848 psi	2,288 psi	4,215 psi



PROFESSIONAL'S CHOICE FOR:

- appliances • bathrooms
- construction
- decks • fountains • glass block
- heavy load applications
- jacuzzis + spas
- landscape architecture
- marine • paving stone systems
- precast concrete & columns
- stone & masonry
- vinyl decking systems

PAVER INSTALLATION ACCESSORIES & GLOVES

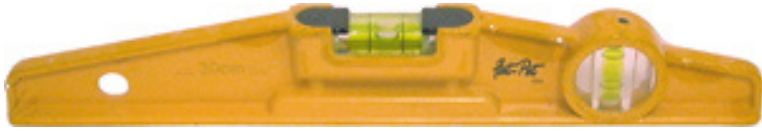

TORPEDO LEVELS #612

12"



3" CHISEL #613

4" CHISEL #614

Brick bolster, case of 25.



CAULKING GUN

419

9" - 24/case



25' TAPE

#609

Case of 6.



SQUEEGEE + POLE

#805

Case pack of 12.



CAULKING GUN

#413

13" - 12/case



PREMIUM KNIT RUBBER PALM GLOVES

#LC21X

Med, Lg, XL, sold by the dozen.



CANADIAN MADE, INDUSTRIAL QUALITY BROOMS

Stiff bristle, heavy sweep exterior use.

18" HEAVY DUTY BROOM #801

24" HEAVY DUTY BROOM #802

BROOM HANDLE #803

BRICK WASHING BRUSH #806

6" x 2.5". Natural fiber for cleaning brick, stone, etc. Case pack of 12.

DRIVEWAY APPLICATOR + POLE #804

Case pack of 12.

ECONOMY KNIT WITH COATED PALM #LC2009

Form knitted shell with latex coating offers an excellent grip. Flexible, comfortable and durable. Sold by the dozen pair.

One size fits all.



TARPS



ALL-SEASON CONSTRUCTION QUALITY, MULTI-PURPOSE TARPS

- 8x8 weave
- 4 spare ropes
- double reinforced corners
- waterproof + rot-proof
- rope reinforced hems
- grommets every 3 ft
- 90 grams/sq meter

- #701** 6FT X 8FT
- #702** 8FT X 10FT
- #703** 9FT X 12FT
- #704** 10FT X 15FT
- #705** 12FT X 18FT
- #706** 15FT X 20FT
- #707** 18FT X 24FT
- #708** 20FT X 30FT
- #709** 24FT X 40FT
- #710** 30FT X 50 FT
- #711** 40FT X 60FT

RETAINING WALL & STAIR LIGHTS

ALL KITS

Voltage: 12V AC/DC
Beam Degree: 120°
Housing: Stainless Steel
Dimensions: 6-7/8" x 3-3/4" x 1/2"
Pigtail Length: 54"

Wattage: 2W
Color Temp: Warm White - 2700K
Lumen Output: 180 Lumens
Number of LEDs: 6 SMD



- Outdoor Lighting
- Plug and Play Wiring - ends can be clipped off to use with a HARDWIRE system
- Excellent for hardscape applications
- Ideal for adding light to any outdoor application
- Low power consumption - 2W
- High Brightness SMD chip technology
- cETLus Listed
- With waterproof connector/plug - IP67
- Dimmable (when used with a dimmable transformer)
- LED light strip is detachable and replaceable
- **Available Trim Colors: Black and Grey and Black Swivel**

120° Rotation of Swivel Light

Direct your light output where you need it to focus



These lights are also available with a swivel light strip

Hardscape Retaining Wall Light LED

#EZWL2-BLK

#EZWL2-GREY

#EZWL2-BLK-SWIVEL



Hardscape Retaining Wall Light 6.9"

Brown Trim
2700K Warm White

#EZWL845PP



Hardscape Retaining Wall Light LED

13.2" Brown Trim
2700K Warm White

#EZWL855PP



Hardscape Retaining Wall Light 6.9" Grey Trim - 2700K Warm White

#EZWL836PP



Hardscape Retaining Wall Light LED

13.2" Grey Trim
2700K Warm White

#EZWL866PP



LED Railing Light Strip 4" with Plug and Play Connector 2 Watts #EZLS2

This LED light strip can be screwed directly into your railing, wall or steps. It's also the replacement strip for our retaining wall light #EZWL2.

Voltage: 12V AC/DC
Beam Degree: 120°
Pigtail Length: 54"
Wattage: 2W
Color Temp: Warm White - 2700K
Lumen Output: 180 Lumens
Number of LEDs: 6 SMD



*For more detailed information on all of our lights, including transformers, plug and play connectors, low voltage wire, etc., please go to: www.brickstopedge.com

NEW

EZFLEX 100
Flexible Connector Clamp

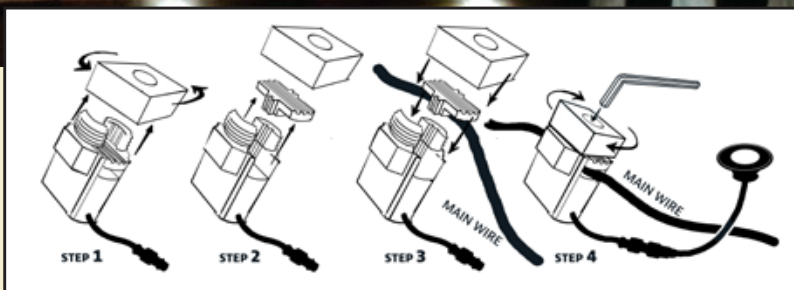

Easily connects our plug and play lights to any hardwire system in seconds with the new EZFLEX Connector Clamp

The EZFLEX Connector's output can be easily adapted to various setups offering unparalleled on-site flexibility.

The connector is designed with pre-installed wires. Simply connect the light fixture with the EZFLEX Connector to the main wire, ensuring quick and hassle-free installation.

Supports up to SPT-3 12AWG double-core wire as the main wire, ensuring stable power delivery. The output wire supports up to 2464 16AWG, meeting various lighting configuration needs.

Equipped with waterproof serrations and high-grade silicone seals, the EZFLEX Connector achieves an IP67 rating, offering superior protection against water and dust.

Features a buckle mechanism for secure installation, reducing time and effort during installation.

Uses a #10 hex key, allowing installers to secure connections with ease.

ALL KITS & LIGHTS

Voltage:	12V AC/DC	Pigtail Length:	11-3/4"
Lens:	Frosted	Wattage:	0.5W
IP Rating:	67	Lumen Output:	44
Mounting Hole Diameter:	1-1/4"	Number of LEDs:	6
Width of Bezel:	1-1/2"		

PLUG & PLAY



- Outdoor Lighting
- Plug and Play Wiring - ends can be clipped off to use with a HARDWIRE system
- Recessed Step and deck light
- Accent Light

- Display and cabinet light
- Spring clips allow simple pressure fit installation
- Fully sealed for outdoor use
- Dimmable (when used with a dimmable transformer)



LED Outdoor Recessed Mini Deck/Patio Light (Spring Fit) - Small Round Metal Trim

#EZDLR12 -

BLK/NKL/WHT

Color Temp: Warm White 2700K



LED Outdoor Recessed Mini Deck/Patio Light (Spring Fit)

Small Round Metal SCOOP Trim

#EZSC12 - BLK/NKL

Color Temp: Warm White 2700K



1.5" BEZEL - ACTUAL SIZE

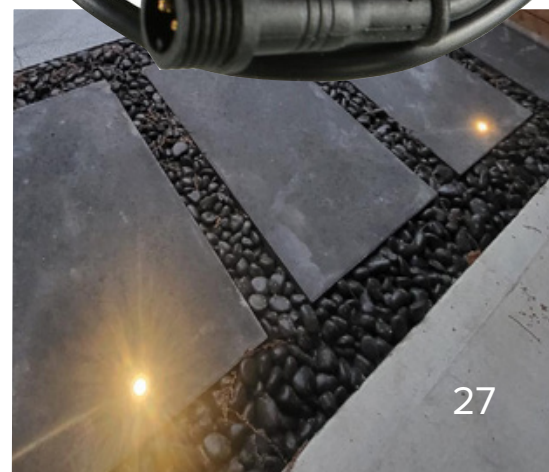

*For more detailed information on all of our lights, including transformers, plug and play connectors, low voltage wire, etc., please go to: www.brickstopedge.com

RECESSED LIGHTS & SPOT LIGHT

LED Outdoor Step, Deck and Inground Light 1 Watt

#EZIL9-NKL

Color Temp:
Warm White 2700K

Voltage: 12V AC/DC
IP Rating: 67
Mounting Hole Diameter: 1-3/4"
Width of Bezel: 2-3/4"
Pigtail Length: 11-3/4"
Wattage: 1W
Color Temp: Warm White 2700K
Lumen Output: 260
Number of LEDs: 1 Power

- Outdoor Lighting
- Plug and Play Wiring - ends can be clipped off to use with a HARDWIRE system
- Deck and step light • Inground landscape light
- With waterproof connector/plug
- Dimmable (when used with a dimmable transformer)
- **Width of Bezel: 2-3/4"**



DRIVE-ON Recessed Light

#EZD13-NKL

In-ground LED light that can be driven on, used in stone or concrete. For stone, cut hole with diameter of 2". For concrete, build wire protection channel using standard PVC pipe, light fits in standard 1.5" PVC coupler.

Voltage: 12VDC
Color Temp: 3000K
Mounting Hole Diameter: 1-1/2"
Wattage: 3W

Width of Bezel: 2-1/2"
Pigtail Length: 59"
Lumens: 275
Beam Degree: 45°



LED Outdoor Recessed Mini Deck/Patio Light (Spring Fit)

Plastic Square Trim
#EZDLS12 - BLK/NKL

Color Temp: Warm White 2700K

#EZDLS12-SS-BLK

*Black available in Stainless Steel



Outdoor LED Garden Spotlight/Uplight

including Stake - 6W

#EZUL6

- Applications: Architectural, Landscape, Accent, Signage
- Innovative solid state COB LED technology
- Simple to install • Non-Dimmable
- Low power consumption
- HARDWIRE Wiring

Voltage: 12V AC/DC
Pigtail Length: 36"
IP Rating: 67
Dimensions: 3.54 x 2.36"
Wattage: 6W
Color Temp: 3000K Warm White

Lumen Output: 480
Beam Degree 45°

PLUG & PLAY



Recessed Flush Light 0.5W

#EZFR35

- Trimless flush mount light
- Plug and Play Wiring - ends can be clipped off to use with a HARDWIRE system
- Applications: deck, step, plinth, patio, pavers, etc.
- White PC housing
- Fully sealed for outdoor use
- > 85 CRI

Voltage: 12V AC/DC
IP Rating: 67
Mounting Hole Dia: 1"
Housing Height: 11/16"
Pigtail Length: 12"
Wattage: 0.5W
Lumen Output: 38
Number of LEDs: 1
Color Temperature: 2700 K

Dimensions

Hole cutout size: Ø1 x H3/4" (Ø25 x H1).
Drill hole with stopper

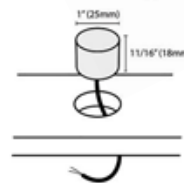

*For more detailed information on all of our lights, including transformers, plug and play connectors, low voltage wire, etc. please go to:

www.brickstopedge.com

LIMITED WARRANTY

All LEDeZe products come with a warranty. Our warranty applies against all defects in workmanship, assembly and materials used in the products. We'll repair or replace, at our sole discretion, any product that fails to operate due to a defect within the following time frames: 3 years for lights and 2 years for transformers.

The warranty does not cover:

- Items which have become damaged due to mishandling, improper installation or use, or resulting from extreme acts of nature.
- Product finish which has faded, rusted, or pitted due to environmental factors.
- Service, installation, or other third party fees incurred due to the defect.



Outdoor LED L-Shaped Path Light
including Stake – 3W
#EZL3

- Metal Stake Included
- Applications: Path, Garden and Landscape
- Simple to install
- Low power consumption
- Waterproof
- Plug and Play Wiring (can be used with a hardwire system simply by clipping off the connector)
- Dimmable (when used with a dimmable transformer)

Voltage: 12V AC/DC
Pigtail Length: 59"
IP Rating: 67
Dimensions: 16" tall
Wattage: 3W
Color Temp: 3000K Warm White
Housing: Stainless Steel
Housing Color: Powder Coated Black

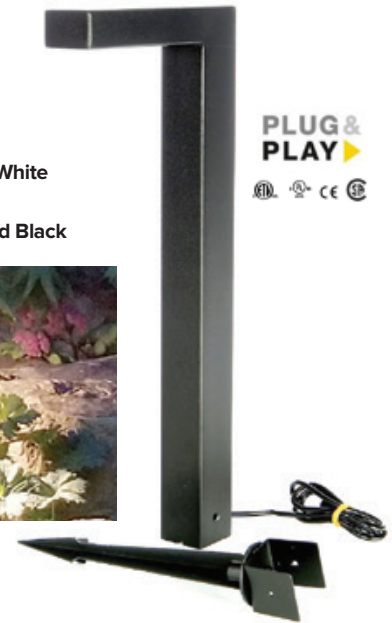

NEW PRODUCT



LED Bollard Light 3W
#EZBL116

2-way splitter attached to fixture which allows for daisy chain connection (1 x 1.5 ft for main cable & 2 x 3 ft with male and female connector). Metal stake included.

Voltage: 12V DC
IP Rating: 65
Dimensions: 15" Tall
Color temp: Warm White (2700K-3000K)
Beam Degree: 165°



LED Modern Bollard Light 10W
#EZBL111

2-way splitter attached to fixture which allows for daisy chain connection (1 x 1.5 ft for main cable & 2 x 3 ft with male and female connector)

Metal stake included
Voltage: 12V DC
IP Rating: 65
Dimensions: 18" Tall
Color temp: Warm White (2700K-3000K)
Beam Degree: 360°
Lumen Output: 500

NEW PRODUCT

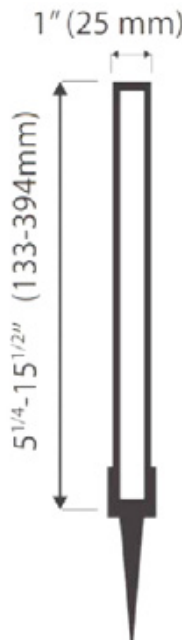

Garden Path Light 6W
#EZPL32

This is a high quality modern fixture that is meant to light up your pathway, walkway, and garden. The housing is made of high grade stainless steel. It includes a stainless steel stake for sturdy application into the ground.



- Stainless Steel Housing
- Stainless Steel Stake Included
- Outdoor Lighting Applications: Path, Garden, Landscape and more
- Low power consumption
- Waterproof
- Plug and Play Wiring (can be used with a hardwire system simply by clipping off the connector)

Voltage: 12V AC/DC
Pigtail Length: 59"
IP Rating: IP65
Dimensions: 15" tall
Wattage: 6W
Color Temp: 2700K Warm White
Housing Color: Powder Coated Black

*For more detailed information on all of our lights, including transformers, plug and play connectors, low voltage wire, etc. please go to: www.brickstopedge.com



LANDSCAPE PRODUCTS

**BRICKSTOP PAVER EDGINGS
HAVE BEEN SPECIFIED AND INSTALLED IN
MANY PRESTIGIOUS LOCATIONS,
INCLUDING:**

The Korean War Memorial
Riverbanks Zoo, Columbia, SC
Wyeth-Ayerst Pharmaceuticals
City of Stockton, CA
University of Toronto
The Aquarium of Bermuda
University of California, Davis Campus
American General Insurance
Stanford University
Paramount Canada's Wonderland
Gillette Stadium, Foxboro, MA
HQ: Make a Wish Foundation of N. TX
Top-of-the-World-Way, Greenbrook, NJ
The Official Residence of the archbishop of the Czech Republic
Essex County 911 Memorial, Eagle Rock Reservation, NJ

...and thousands more.

WWW.BRICKSTOPEDGE.COM