



LANDSCAPE PRODUCTS

2024

www.brickstopedge.com
1.800.565.2599

MISSION STATEMENT

At Brickstop Corporation our goal is to manufacture, distribute and supply our dealer network with the finest quality Paver Edgings and Landscape Accessories, serving the professional landscape contractors' specific needs and requirements.

We strive to provide the best tools possible so you can do the best job possible!

Our customers' needs are our priority. If you can't find a product you require, we are happy to source it for you.

Thank you for your interest in our fine line of superior products.

We're the "good guys to deal with!"

Plastic Paver Edging

- 02** BEAST #350
- 03** Edgeall Low Profile #370 and Simflex Paver Edging #250

Aluminum Paver and Lawn Edging

- 04** Brickstop Original L shape #150
- 05** L shape Economy Aluminum #170 & Low Profile Aluminum #120
- 06** Edgestar 4" Aluminum Lawn Edging #210
- 07** Plastic Lawn Edging / Geogrid
- 08** Adhesive - Brickstik XS
- 09** Hammers
- 10** Block and Paver Splitters
- 11** Block and Paver Splitters
- 12** Slab Transporters and Levelling Machine
- 13** Heavy Lifting Equipment and Sections Clamps
- 14** Curb Lifting Equipment and Clamps
- 15** Curb Lifting Equipment and Clamps / Tamper Mat Pro
- 16** Paver Hand Tools & Hand Lifters
- 17** Paver Hand Tools & Hand Lifters / Screeding Tools & Rakes
- 18** Wall Drains and Ground Drains
- 19** Hand Vacuum Lifter
- 20** Marking Paint / Pallet Wrap / Shims
- 21** Paver Installation Accessories / Gloves / Tarps
- 22** LED Lights - Retaining Wall and Stair Lights
- 23** LED Lights - Recessed Lights and Recessed Stair Light
- 24** LED Lights - Recessed Lights
- 25** LED Lights - Path Lights and Spot Light

B.E.A.S.T. PLASTIC PAVER EDGING #350



**NORTH AMERICA'S
#1
BEST SELLING
PAVER EDGING**

Over thirty years of experience and millions of feet of paver installations have gone into the development of the B.E.A.S.T.

B.E.A.S.T. #350



- Just one piece does both straight lines and curves
- Staggered lattice nailing to ensure maximum hold
- Extra wide base for increased stability
- Easy to install with 10" or 12" nails
- Allows natural vegetation growth
- 100% recycled plastic

Wall: 1.75"
Foot: 3"
Width: 2.5"
Available in 8 ft lengths

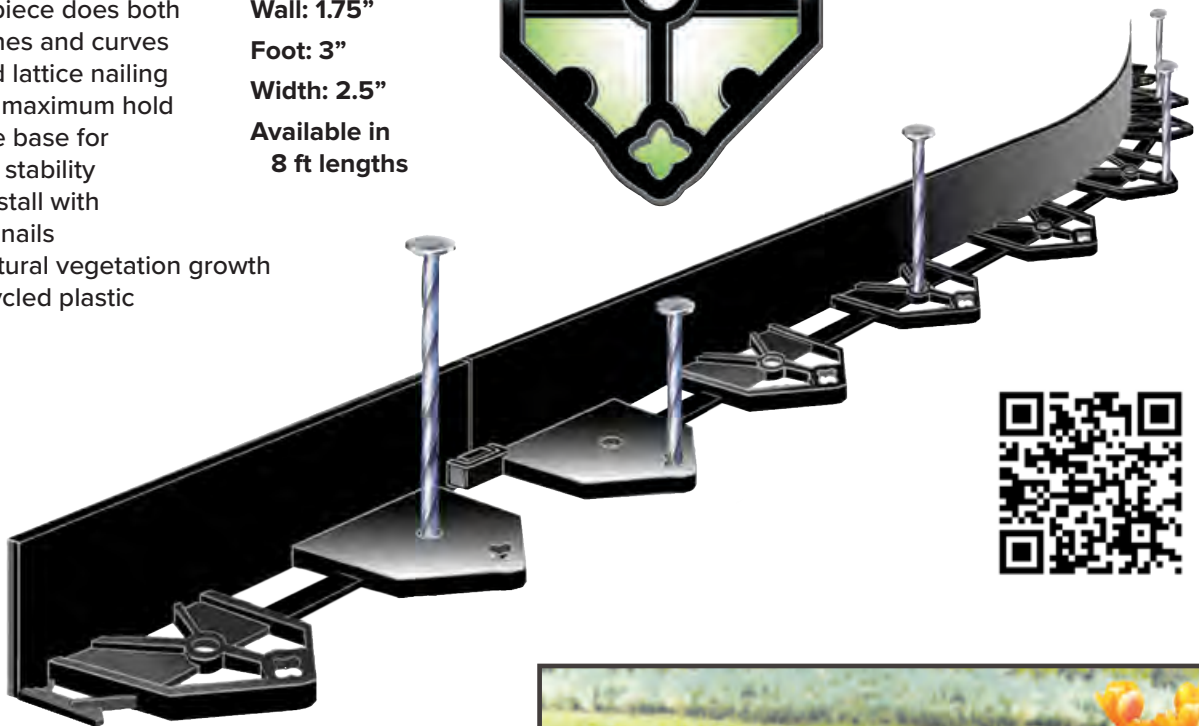

STEEL SPIRAL SPIKES #400

Sold in individual 50lb. boxes or by the pallet (48 cases)

10" - approx. 235 Steel spiral spikes

12" - approx. 210 steel spiral spikes

Common nails available



EDGE-ALL LOW PROFILE PAVER EDGING #370

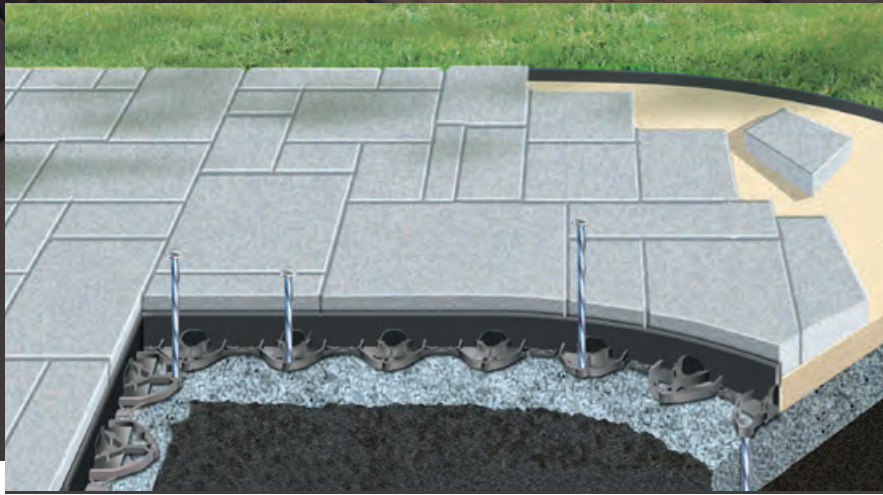

EDGE-ALL



EDGE-ALL #370



- Ideal for thin pavers, wetcast stone, and flagstones
- Super strength
- Super flexibility
- Amazing straight lines
- Perfect curves

Wall: 1.5" Foot: 2.25" Available in convenient 6 ft lengths

STEEL SPIRAL SPIKES #400

Sold in individual 50lb. boxes or by the pallet (48 cases)

10" - approx. 235 Steel spiral spikes

12" - approx. 210 steel spiral spikes

Common nails available



SIMFLEX PLASTIC PAVER EDGING #250

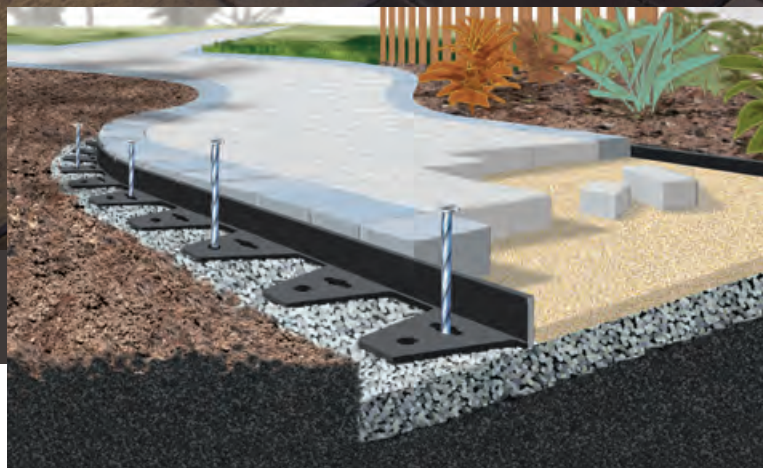

**SIMPLE,
FLEXIBLE,
AFFORDABLE**



SIMFLEX #250

- Installs easily
- Requires no cutting for curves; suitable for both straight and radius installations
- Ideal for driveways, walkways and patios
- Thick profile manufactured from recycled plastic

Wall: 1.625" Foot: 2.75" Thickness: 0.31" Convenient 7'6" sections

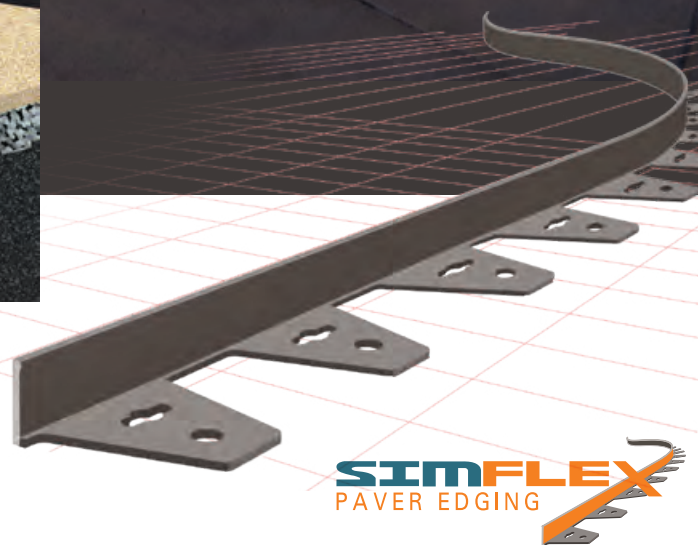

SIMFLEX
PAVER EDGING

ALUMINUM PAVER EDGING #150



**Brickstop
Advantages:**

THE ORIGINAL L-SHAPED PAVER EDGING

Because your reputation is at stake.

BrickStop Aluminum Edging bends to your needs no matter how complex your interlocking brick and paving stone design. Made of aluminum, it's strong enough for straight lines, yet flexible enough to follow the most intricate curved patterns, with optional installation of pavers on either side of the edging.

BrickStop Aluminum Edging prevents the shifting and movement of pavers that could turn your project into an eyesore. BrickStop comes through with a patented design that lets you form 90 degree angles without cutting. Its quick "either side" installation helps bring labour costs down and creates the long lasting results that will keep customer referrals coming year after year.

- Convenient 8'4" lengths
- Made of non-rusting recycled aluminum
- Allows installation of pavers on either side of edging
- Completely hidden from view
- One piece for straight or curved patterns
- 90 degree angles without cutting
- Will not warp in heat or crack in cold
- No loss of material due to overlap at joints
- Includes plastic joiner tab



ORIGINAL #150

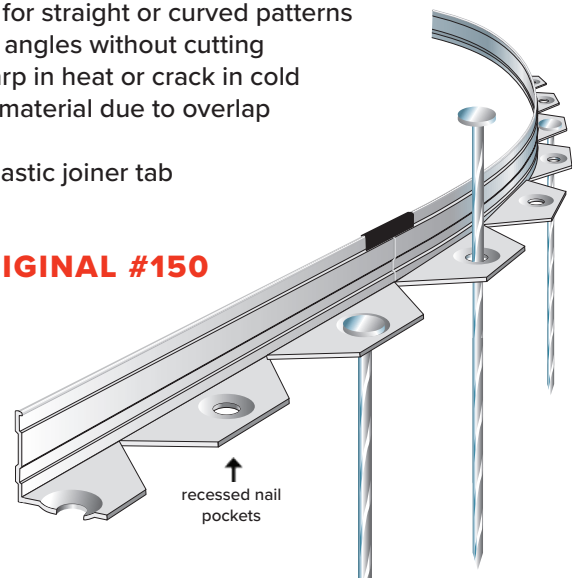

STEEL SPIRAL SPIKES #400

Sold in individual 50lb. boxes
or by the pallet (48 cases)

10" - approx. 235 Steel spiral spikes

12" - approx. 210 steel spiral spikes

Common nails available



Length: 8'4" (2.54m)

Height: 1.5" (35mm)

Thickness: 0.125" (3.2mm)

Flange: 1.5" x 4" (35mm x 102mm)

Alloy: 6063 aluminum

T-5 hardness

US Patent

ALUMINUM PAVER EDGING #170



#170 - THE ECONOMY L-SHAPED PAVER EDGING

An economical option to our original #150 Paver Edging, with all the same attributes that aluminum paver edging offers.

Allows installation of pavers on either side of edging.

Length: 8'4" (2.54m)
Height: 1.5" (35mm)
Thickness: 0.105" (2.67mm)
Flange: 1.45" x 4" (34mm x 102mm)
Alloy 6063 Aluminum
t-5 Hardness

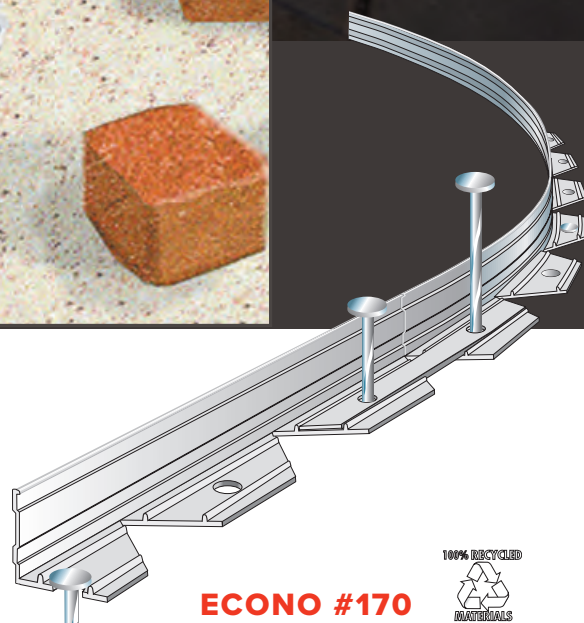

LOW PROFILE ALUMINUM EDGING #120

Brickstop's Lowest Profile Aluminum Edging is ideal for use with 20mm porcelain pavers, flagstone, wetcast shapes and bluestone. Our aluminum edging bends to your needs no matter how complex your design requirements. Made of aluminum, it's strong enough for straight lines, yet flexible enough to follow the most intricate curved patterns.

LOW-PROFILE ALUMINUM EDGING #120

- Convenient 8' lengths
- Made of non-rusting recycled aluminum
- Allows installation of pavers on either side of edging.
- Completely hidden from view
- One piece for straight or curved patterns
- 90 degree angles without cutting
- Will not warp in heat or crack in cold
- No loss of material due to overlap at joints



Length: 8'4" (2.54m)
Height: 5/8" (17mm)
Thickness: 0.125" (3.2mm)
Flange: 1.5" x 4" (35mm x 102mm)
Alloy: 6063 aluminum
T-5 hardness





Sizes: 1/8" by 4" (3.2mm by 100mm)
residential/commercial

Finishes: Mill finish; natural aluminum or black anodized

Length: 8'0" (2.44M) sections – nail every 23"

Nails: 10" by 3/8" spiral steel nails (not included)

Convenient 8' Sections

EDGE STAR ADVANTAGES:

- Keyhole Interlocking System: Lengths are easily and quickly connected.
- Superior Reinforcement – 8' lengths: Rigid enough to provide perfectly straight lines; flexible enough for the most demanding curves.
- No need to use heavier gauge or more costly material to maintain straight runs.
- Heavy duty 1 1/8" nail loops located every 23": allows for more frequent nailing positions, providing superior anchoring where required.
- Steel Nail Anchoring: Spiral 10" nails readily available.

EDGE STAR is produced in 1/8" thickness. Our product's design will maintain straight lines even for the heaviest commercial applications. EDGE STAR is ideally suited for use as a planting bed edging in both residential and commercial applications. Other uses include edging for walkways, jogging trails, running tracks, asphalt borders and maintenance strips.

Available in black anodized.

KEEPS GARDEN BEDS CLEAN AND NEAT!

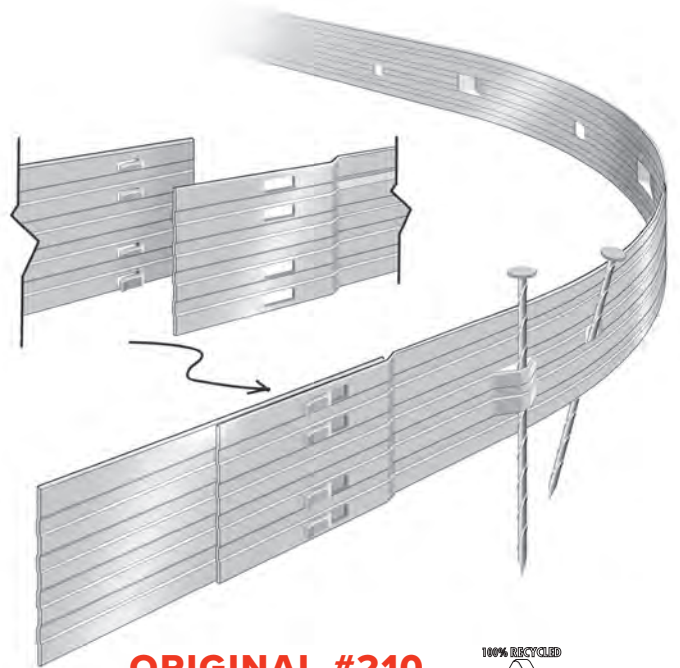

ORIGINAL #210
WITH SNAP-IN INTERLOCKING TABS



STEEL SPIRAL SPIKES #400

Sold in individual 50lb. boxes
or by the pallet (48 cases)

10" - approx. 235 Steel spiral spikes

12" - approx. 210 steel spiral spikes

Common nails available





GREENLINE LAWN/LANDSCAPE EDGING

PRO-T #240



- Corrugated side wall construction
- Rigid yet flexible, will easily follow the contours of your design
- "T"-shaped base resists frost heave
- Convenient, easy-to-handle 8 foot lengths
- 10 strips per bundle (anchoring stakes, straight or corner connectors sold separately)
- Clean lines provide for ease of installation
- "V"-shaped base resists frost heave
- Convenient, easy-to-handle 8 foot lengths
- Economically priced
- 10 strips per bundle (anchoring stakes, straight or corner connectors sold separately)

PRO-V #260



ACCESSORIES

#261 9" Galvanized Steel Anchoring Stakes

#262 6" Straight Connector

#263 90 Degree Corner Connector

GEOGRID RETAINING WALL SYSTEM

- **BG100** BIDIRECTIONAL
4' X 50' **DEALER DISPLAY**
22 SQ.YDS (12 ROLLS/CS.)
- **BG150** BIDIRECTIONAL
6' X 150', 100 SQ.YDS.
- **BG200** UNIDIRECTIONAL
6' X 300', 200 SQ.YDS.
- **BG350** UNIDIRECTIONAL
6' X 300', 200 SQ.YDS.

OTHER SIZES AVAILABLE UPON REQUEST

Geogrid provides advanced options for dealing with common civil engineering problems and difficult soils. The highest quality for retaining walls, reinforced steep slopes and embankments over soft soils.

Geogrid is constructed of high molecular weight and high tenacity polyester yarns utilizing a complex knitting process and low temperature coating technology to provide superior engineering properties. UV stabilized coating provides further chemical and mechanical benefits.

GEOGRID BY BRICKSTOP IS USED FOR:

- Retaining Walls
- Landscape Repair
- Timber Walls
- Paver Reinforcement
- Steep Slopes



SPECS

Biaxial **LTDS:**
MD 822 lbs/ft

CMD: 882 lbs/ft

Recommended for wall heights up to 6'

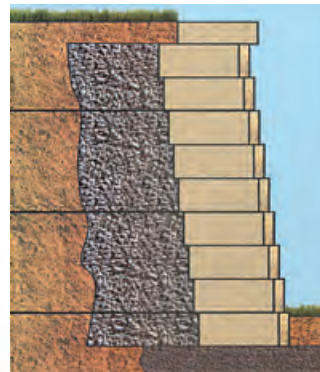



**EXTRA
STRENGTH**

**HEAVY DUTY PREMIUM
POLYURETHANE FOR
CONCRETE AND STONE**

Brickstop Brickstik is a one-component premium polyurethane adhesive. Specially formulated to adhere to wet or frozen surfaces. Brickstik is specifically engineered for the Concrete and Paver/Retaining wall industry.

Brickstik is designed to resist water and frost to permanently bond stone, brick, and concrete. Brickstik can be applied in a wide installation temperature span and will not freeze.



FEATURES AND BENEFITS:

- VOC Compliant
- Environmentally sensitive
- Easy gunning – user friendly
- Fast curing – quicker adhesion

#1010 10.5 OZ (313ml), 24/CASE

#1028 29 OZ (858ml), 12/CASE

SUBSTRATE BOND STRENGTH		24 HOURS	7 DAYS:
Concrete to Concrete		300	350
BEAD SIZE IN INCHES (MM)	LINEAL FEET PER 313 ML	LINEAL FEET PER 858 ML	
1/8 (3)	129	353	
3/16 (5)	57	156	
1/4 (6)	32	87	
5/16 (8)	20	54	
3/8 (10)	14	38	



PAVER MALLET #602-6

13" Handle - 2³/₈" Head, 3.5lbs.

This mallet is made of cast iron and has replaceable inserts. It's perfect for large wall projects. Comes with a life-time warranty.

- INSERTS INCLUDED:**
1. Black Composite Rubber/medium hard
 2. Red Plastic/hard

WALL MALLET #602-8

19" Handle - 3¹/₈" Head 6.6 lbs.

Ideal for retaining wall cap stones. Comes with a life-time warranty.

- INSERTS INCLUDED:**
1. Black Composite Rubber/medium hard
 2. White Nylon/hard

BP PAVER MALLET #696-8

9.5" Handle - 2" Head 3.2 lbs.

This is a soft-face mallet. It is designed with two different inserts of varied hardness. This is a great mallet to use for small adjustments without damaging your products. Comes with a life-time warranty.

- INSERTS INCLUDED:**
1. White Nylon/hard
 2. Red Plastic/hard



DEAD BLOW (40MM) #636-4 14" Handle - 4" Head, 1.6 lbs.

DEAD BLOW (70MM) #636-7 14¹/₂" Handle - 4¹/₂" Head, 5 lbs.

This dead-blow mallet has a steel head with replaceable nylon inserts. A sealed container, within the insert, is filled with a steel shot for a rebound-free strike. Comes with a life-time warranty.

- INSERTS INCLUDED:** 1. White Nylon / hard



SLEDGE MALLET #602-7

31" Handle - 3¹/₈" Head 7.4 lbs.

This sledge mallet is the perfect tool for damage-free, major adjustments. Comes with a life-time warranty.

- INSERTS INCLUDED:**
1. Black Composite Rubber / medium hard
 2. White Superplastic/medium hard

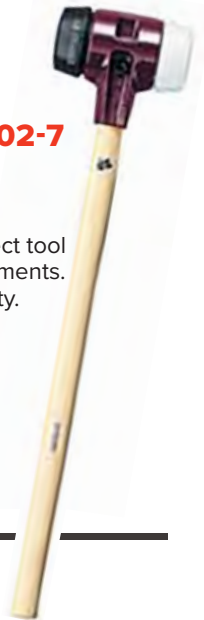

REPLACEMENT INSERTS



WHITE NYLON

- For item #602-8 use insert #620-88
- For item #636-4 use insert #650-84
- For item #636-7 use insert #650-87
- For item #696-8 use insert #698-85



RED PLASTIC

- For item #602-6 use insert #620-66
- For item #696-8 use insert #696-65



WHITE SUPERPLASTIC

- For item #602-7 use insert #620-78



BLACK COMPOSITE RUBBER

- For item #602-6 use insert #620-26
- For item #602-7 use insert #620-28
- For item #602-8 use insert #620-28



PAVER PERSUADER #503

New galvanized steel 36" handle, 8 lbs.



DOUBLE HEADED PAVER MALLET #412

Galvanized Steel 15" Handle Flat Head, weight: 5.5 lbs



GUMMY MALLET #601

32 oz, made in Italy



CLUB HAMMER #602

2.5 lbs. with fiberglass handle, case of 6



RUBBER MALLET #603

32 oz, Case of 24



DEAD BLOW #605

4 lbs, case of 12



MASON HAMMER #607

24 oz. with fiberglass handle, case of 6



BLOCK & PAVER SPLITTER

#FBS40

Designed for splitting: • Retaining Wall • Cap Stone • Rough Cut Face Stone • Paving Stones • Most flat stone materials on the market today

Tough metal hubcap and rubber wheels.

Spring loaded tray for angled “undercuts” when cutting pavers

Easy one dial system: (unlike two dials) for perfect cuts every time (No need to set screw every time when cutting same size stone)

GREAT CUTTING RANGE:

Cutting Width: 16”
Cutting Height: 8.3”
Weight: 135 LBS.



HYDRAULIC BLOCK AND BRICK SPLITTER #FBS60

Designed for splitting: • Retaining Wall • Cap Stone • Rough Cut Face Stone • Granite • Paving Stones - and most other flat stone materials on the market today • Over 20 ton cutting force

Spring loaded tray for angled “undercuts” when cutting pavers

Adjustable blade height: for all ‘flat faced’ products up to 235 mm

Heavy weight construction: takes a lot of abuse

Reversible blades: with 3 cutting edges



Cutting Width: 25.6” **Width: 32.28”**
Cutting Height: 9.25” **Height: 40.95”**
Length: 28.74” **Weight: 218.26 lbs**



BLOCK & PAVER SPLITTER

#BSN-006

Fixed hardened galvanized knife, 4 edges

GREAT CUTTING RANGE

Cutting Width - 13"

Cutting Height: - 1/2" - 6"

- Weight - 80 lbs
- 2 spindles to adjust height



*Except Wearing Parts

ALL SPLITTERS HAVE A:

- Holding plate
- Spring Loaded Cut



BLOCK & PAVER SPLITTER

#BSN-007

- 2 Spindles for height adjustment
- Spring loaded with plate holder for stone
- Galvanized blade
- Powder coated



*Except Wearing Parts

GREAT CUTTING RANGE:

Cutting Width: 17"

Cutting Height: 1/2" – 6"

Weight: 125 LBS.



BLOCK & PAVER SPLITTER

#BSN-008

- 2 Spindles for height adjustment
- Spring loaded with plate holder for stone
- Galvanized blade
- Powder coated



*Except Wearing Parts

Great cutting range:

Cutting Width: 17"

Cutting Height: 1/2" – 11.8"

Weight: 145 LBS.



*Except Wearing Parts



PAVER CUTTER

#MBSN-009

- Powder coated
- Great for small cuts on the go!

Cutting Width: 4.5"
Cutting Height: 0" – 4.5"
Weight: 6 LBS.



SUPER SCREED LEVELLING MACHINE

#M-510

Perfect for a quick and accurate screening for pavers
Good for levelling planting beds, gravel and wood chip areas, rooftop beddings

- Minimum width setting 29.2"
- Maximum width setting 48.8"
- Tough powdercoat
- Scraper panel made of non-rusting steel
- Galvanic zinc plating
- Weight 46.3 lbs.
- 9.8" diameter rubber wheel, height adjustable
- Dimensions: 28.8" x 19.7" x 15.8"



*Except Wearing Parts



24" SLAB TRANSPORTER / CADDY

#ST-430

Ergonomic design can lay slabs hands free

- Lifts from 11.8" - 23.6"
- Weight 33 lbs.
- Tough powdercoat



*Except Wearing Parts



39" SLAB TRANSPORTER / CADDY

#ST-530

Ergonomic design can lay slabs hands free

- Lifts from 11.8" - 39"
- Weight 50 lbs.
- Tough powdercoat
- Short arm adjustable from 11.8" to 21.6"
- Long arm adjustable from 23" to 40"



GREAT FOR LIFTING LARGE SLABS

EASES THE STRESS ON YOUR BACK!



*Except Wearing Parts





Our clamps are made by BSV in Denmark. They have been making clamps for 110 years and your operators will fight for the truck that's equipped with the BSV.

All clamps protect the product with rubber contact pads for safe and easy loading and offloading. All clamps are gravity controlled – they open when rested and close when lifted.

We can supply custom clamp solutions if you require a clamp or grab not shown. Many other sizes and configurations are available by special order. Be sure to describe your needs to your salesman as not all clamps are suitable for fork-truck use.



CLAMP #BSV 32/38

For moving the heavier stuff. The 32/38 will safely lift loads from 32" to 38" and up to 4070 lbs. This clamp will perform.



SECTIONS CLAMP

#1002

With the versatile lifting range of 9"-42" and a safe working load of 1600 lbs., this clamp is capable of picking up 1-2 sections of pavers at a time. The 1002 is perfect for separating cubes of pavers and handling materials on site. Fork Yoke Attachment available. **Made in Canada.**

SCISSOR CLAMP

#BSV MULTI

760/50Z



The width of this clamp can be adjusted from 15.75" to 42". A maximum safe working load of 3,300 lbs, the scissor clamp is extremely versatile and ideal for heavy-duty multi-purpose use. Pictured with optional fork yoke.

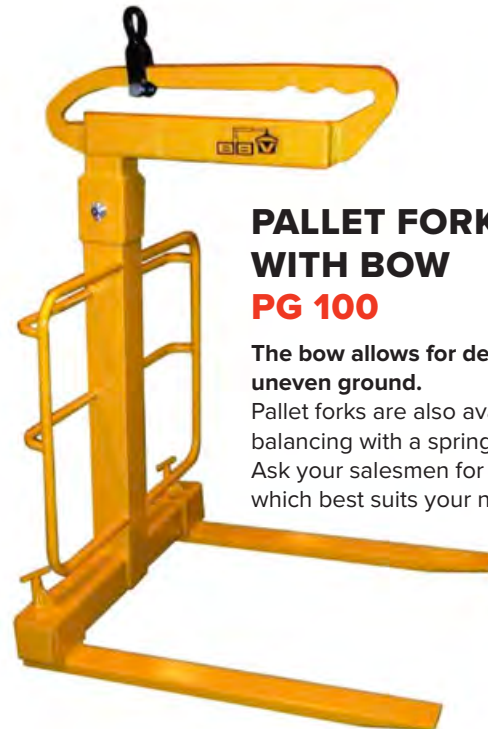

PALLET FORK WITH BOW

PG 100

The bow allows for deliveries on uneven ground.

Pallet forks are also available as self balancing with a spring loaded head. Ask your salesman for the model which best suits your needs.



TREADSETTER #600T/1200T

Eliminate finger smashing, back breaking, time consuming and work-related injuries using the new TREADSETTER. The Treadsetter is designed to handle various step treads from 12"-35" in depth – up to 4" in width and with a 6"-8" rise. This new product is easily adjusted to tread width and balance. The tool has pivot-style urethane ends to reduce slippage and protect the stone, as well as servicing other applications in various weather conditions. Ideal for Rosetta Stone.

TWO SIZE AND WEIGHT CAPACITIES

#600T: 600 lb Treadsetter, 12"-25" in depth

#1200T: 1200 lb Treadsetter, 20"-35" in depth

OCTOPUS LIFTING CURB CLAMP

#RT101

Suitable for handling steps, curbs, L-stones, etc. with a lifting device. Easily adjustable quick spring bolt opening. Curved curb stones are also gripped securely, as the gripper has an inside height of 7" enabling grip from underneath. Automatically opens upon release.

- Weight: 73 lbs
- Clamping depth: 7.4"
- Max. load: 1322 lbs
- Min. width setting: 1.9"
- Max. width setting: 23.5"
- Surface Treatment: Powder Coated Yellow
- Product dimensions: 26" x 23" x 33"



7 YEARS WARRANTY
*Except Wearing Parts



SCISSOR CLAMP MODEL

#10-38

A lightweight clamp suitable for lifting curbs and other narrow stones. Lifts from 4" to 15" at a maximum safe working load of 1540 lbs.



MONTOLIT CURB CLAMP

#A016 (R)

Mechanical or hand-lifter. 3.15"-7" 440lb capacity

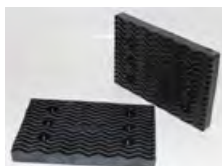

JED CLAMP IT / TREAD/CURB CLAMP

#J900 4"-22" max width 900lbs

#J2400 8"-32" max width 2400lbs

#J3000 12"-42" max width 3000lbs

CURB LIFTING EQUIPMENT & CLAMPS



EASY GRIP LIFTING CLAMP #RT202

Ideal for handling stone with flat surfaces. Attachable to loading crane, mini-excavator/skid. Steer to allow one person to guide for precise placement. Two handles also allowing for a two-man manual operation.

- Range - 1/2" - 16.5"
- Weight - 28 lbs
- Depth - 5.5
- Max Load 1200 lbs.

TAMPER MAT PRO



TAMPER MAT PRO #510

High-Modulus Polyethylene Thermoplastic

- Attaches to many different plate compactors with its universal size of 19" wide x 24" long x 0.25" thick. Flexible front lip.
- Matt includes 1 pair universal aluminum mounting brackets.
- May be cut down to small sizes

- Quick attachment at any point during a project without slowing down the job.
- Keeps the travel speed and compaction force you need when making that critical final pass over the pavers and poly sand.
- Lasts a long time – high abrasion resistance and low coefficient of friction.

*Wacker - TM of Wacker Neuson Corp.



PAVER EXTRACTOR GALVANIZED

#502N

Adjustable: 7.8"-11.8"
Weight: 10 lbs



*Excluding teeth



PAVER-PRY

#504

The ideal tool for positioning pavers and checking joints.

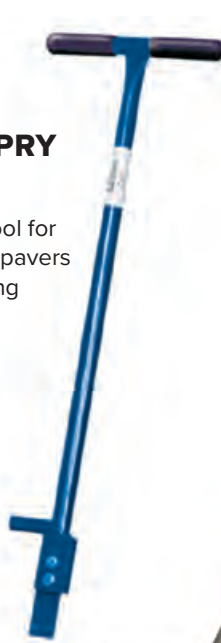

12" SLAB LIFTER

#506

- Lifts from 4" - 12.75"
- 2 spring steel teeth included
- Galvanized steel
- Replaceable teeth



*Except Wearing Parts



2 MAN CURB LIFTER

#2CL425

- Range 19.5"-43"
- Max weight 330 lbs
- Detachable for bobcat / Skid Steer
- Galvanized, non rusting
- Weight 25 lbs



*Not Including Pads



TWO MAN CURB STONE LIFTER

#2CL525

- Range - 1/2" - 11.5"
- Depth - 8.25"
- Max weight 440 lbs
- Weight - 26 lbs
- Galvanized - non rusting



*Except Wearing Parts



20" BLOCK/PAVER LIFTER

#M-002

- Lifts from 11.4" - 20.8"
- Lifts up to 50 lbs.
- Tough powdercoat



*Except Wearing Parts



24" GIANT SLAB LIFTER
#M-003

- Lifts from 7.9" - 24"
- Lifts up to 130 lbs.
- Galvanized steel
- Ergonomic design



SCREEDING TOOLS & GRADING RAKES

ALUMINUM SCREED BAR

Lightweight, hollow. 1" x 4". Lengths: 4', 6', 8'.

#509-4 - 4FT

#509-6 - 6FT

#509-8 - 8FT



ALUMINUM SCREED RAIL #508

Helps set levels. Lightweight. 1" x 8'.

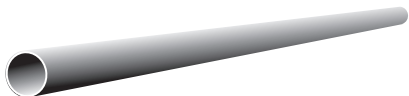

LANDSCAPE/GRADING RAKE

The strongest aluminum rake money can buy! All-aluminum construction – lightweight, 5.5 lbs. (36" and 48")

Extra thick tines, up to 50% more material and an extended striking edge to reduce dirt buildup. 66" aluminum alloy handle is powder-coated to eliminate blackened hands. Head connection is secured with a solid aluminum plug for maximum strength. Wrap-around bracing.

WALL DRAINS & GROUND DRAINS

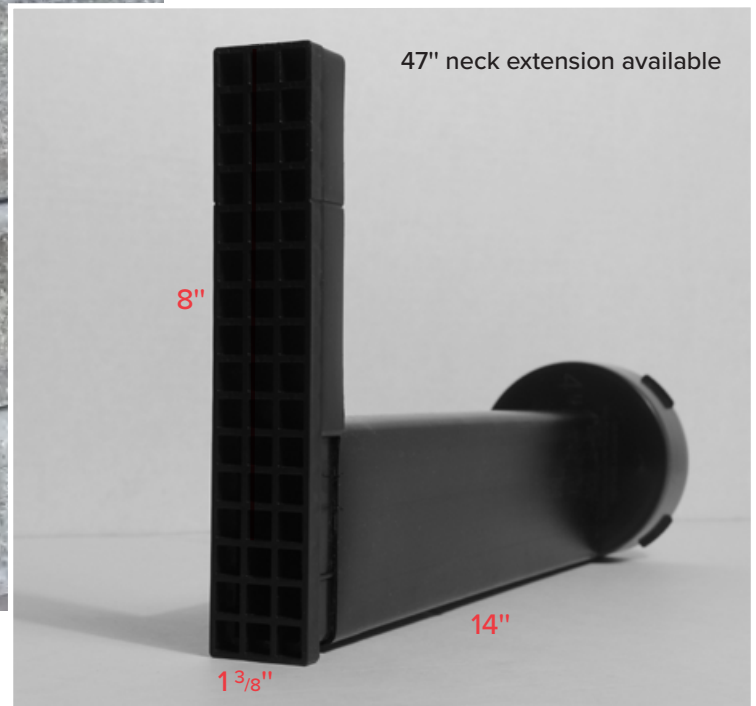

UNIVERSAL WALL DRAIN PRO

#WDP03/WDP04

- designed for all 3"-8" block easy installation
- aesthetically pleasing
- reduced labour costs
- height easily modified for use with any size block or timber

#WDP03

- male end snaps into 3" piping

#WDP04

- male end snaps into 4" piping

CHOOSE YOUR COLOUR



grey

tan

black



DRAINAGE KIT #PC100A

This is ideal for below grade driveways.

DRAINAGE KIT INCLUDES:

- 3 drains (39" each)
- 3 stainless steel grates
- 1 solid end cap (#DN75)



REPLACEMENT CLIP #PC100C

(FOR #PC100A)

END CAP FOR 4" PIPE #PC100B



SOLID END CAP #DN75

(FOR #PC100A)



GRABO Pro 2.0

"Heavy Lifting Made Easy"

PORTABLE ELECTRIC VACUUM LIFTER

GRABO PRO-LIFTER 2.0 #530



The GRABO Pro-Lifter is designed for professionals.

The tool is portable and handy. Equally effective on smooth as well as coarse surfaces. Has a pumping capacity of 20 liters per minute, a best in class. Say good-bye to unreliable, and often dangerous, manual suction cups for the job. With GRABO Pro you double your work efficiency with enhanced safety.

Ergonomically designed to provide better grip and less fatigue when moving heavy objects. An effective vacuum lifter even for dusty, semi-porous or rough surfaces. Works perfectly with glass, wood, ceramic tiles, metals and other materials. The powerful vacuum pump and rechargeable battery pack are concealed within the grab handle.

KIT INCLUDES:

GRABO Pro-Lifter comes as a complete unit, with pre-installed battery and vacuum seal.

That is not all. There are other accessories in the kit, including a multi-socket charger and a heavy duty carry bag. The complete kit is packaged in a functionally designed colorful box.

Package Contents:

- 1 GRABO Pro tool (2021 model with digital display)
- 1 multi-socket charge
- 1 seal (preinstalled on the tool)
- 1 battery (preinstalled on the tool)
- 1 tough Oxford fabric carry bag
- Operator's manual in English



LANDSCAPE PRODUCTS



ACCESSORIES



ERGUO S1 portable lifting attachment #525

Reduce work related fatigue or injuries. AVOID an impact on your back from working long days in a bent down position to lift materials.

Operate the GRABO tool without bending. The attachment easily fits into the 4 lifting lugs next to the grab handles of the tool. Simply activate the GRABO tool to lift your material, lift and position the material, and release the tool from the material – in one swift motion without bending down. The actuator on the handle bar helps in controlling the functions. Compatible with all models, except the Grabo H as that is designed for simpler and shorter duration usage.



High-capacity spare battery #523

If you are working in a remote location or need spare batteries, then just order as many from any of our suppliers.

These batteries are as powerful as the ones supplied with the tool. A full battery charge delivers up to 900 operating cycles or 1.5 hours of uninterrupted run time. The high-capacity battery can be used with all models except GRABO H.



Extra Seals #522

With continuous usages the seals wear out. When the GRABO seal finally wears out, the lifting capacity diminishes. In this case you can replace the worn seal by hand within seconds.

You can use the spare one supplied with the kit. Alternatively you can buy as many from any of the distributors or retailers. This patented high friction foam-rubber seal fits all GRABO models.



RockSeal™ #524 is a new seal system that fits all GRABO models, including Nemo GRABO, GRABO Pro lifter-20, RTC tools GRABO, FXAH-120 Probst GRABO, Topspin Powertools GRABO and other co-branded units.

This patented seal is designed specifically for extremely rough stone & rock surfaces with up to 10 mm surface profile.

WILL NOT WORK WITH POROUS STONE.

GRABO Pro 2.0 Weight lifting safety parameters

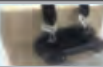

Material / Direction	Glass	Ceramic tiles	Metal	Plastic	wood	Rough Slate	Rough Concrete	Dry Wall
 PERPENDICULAR HOLD	375 Lbs (170 kg)	375 Lbs (170 kg)	242 Lbs (110 kg)	220 Lbs (100 kg)	220 Lbs (100 kg)	176 Lbs (80 kg)	176 Lbs (80 kg)	165 Lbs (75 kg)
 PARALLEL HOLD	265 Lbs (120 kg)	265 Lbs (120 kg)	242 Lbs (110 kg)	220 Lbs (100 kg)	143 Lbs (65 kg)	176 Lbs (80 kg)	176 Lbs (80 kg)	143 Lbs (65 kg)

GRABO

GRABO #520

- KIT INCLUDES:** · 1 - rechargeable batterypack · Charger · Canvas bag · One foam rubber seal · Filter



Material / Direction	Glass	Ceramic tiles	Metal	Plastic	Wood	Rough Slate	Rough Concrete	Dry Wall
 PERPENDICULAR	375 Lbs	375 Lbs	242 Lbs	220 Lbs	220 Lbs	176 Lbs	176 Lbs	165 Lbs
 PARALLEL	265 Lbs	265 Lbs	242 Lbs	220 Lbs	143 Lbs	176 Lbs	176 Lbs	143 Lbs

BRICKSTOP INVERTED MARKING PAINT

#550

FEATURES AND BENEFITS:

- Ultra bright
- Inverted tip
- Fast dry – non clogging
- Water based – safe on grass and plants
- Lead free – VOC Compliant
- Colors – Fluorescent Orange, Fluorescent Red, Hot Pink, White
- 12 – 482 gr. cans/cas
- 17 oz.



PALLET WRAP (CAST)

#PW-001

Stronger and has more stretch than blown, use less wrap per pallet.

- Ideal for Stoneyard material
- Durable film resists punctures for increased load retention
- Clear film to keep your wrapped products visible
- Cast hand wrap, 2-sided cling
- 15" x 1500" x 80 guage
- 4 Rolls per case
- 48 Cases per pallet



EZ-SHIM™ #512

THE ALL PLASTIC LOAD BEARING SHIM



FEATURES AND BENEFITS:

- LOAD BEARING up to 8,000 psi • WEATHERPROOF
- Easy break off points • Handles big nails and screws
- Injection molded into sheets of ten / 36 sheets per case



LOAD TESTED

Compression (downward force) until deflection. Results measured in psi (avg.)

		HEEL	MID	TOE
EZ-SHIM		8,029 psi	7,993 psi	7,947 psi
CEDAR		1,367 psi	1,711 psi	5,370 psi
PINE		1,848 psi	2,288 psi	4,215 psi



PROFESSIONAL'S CHOICE FOR:

- appliances • bathrooms
- construction
- decks • fountains • glass block
- heavy load applications
- jacuzzis + spas
- landscape architecture
- marine • paving stone systems
- precast concrete & columns
- stone & masonry
- vinyl decking systems

PAVER INSTALLATION ACCESSORIES & GLOVES



TORPEDO LEVELS #612

12"



3" CHISEL #613

4" CHISEL #614

Brick bolster, case of 25.



CAULKING GUN

419

9" - 24/case



25' TAPE

#609

Case of 6.



SQUEEGEE + POLE

#805

Case pack of 12.



CAULKING GUN

#413

13" - 12/case

CANADIAN MADE, INDUSTRIAL QUALITY BROOMS

Stiff bristle, heavy sweep exterior use.

18" HEAVY DUTY BROOM #801

24" HEAVY DUTY BROOM #802

BROOM HANDLE #803

BRICK WASHING BRUSH #806

6" x 2.5". Natural fiber for cleaning brick, stone, etc. Case pack of 12.



DRIVEWAY APPLICATOR + POLE #804

Case pack of 12.

PREMIUM KNIT RUBBER PALM GLOVES

#LC21X

Med, Lg, XL, sold by the dozen.



ECONOMY KNIT WITH COATED PALM #LC2009

Form knitted shell with latex coating offers an excellent grip. Flexible, comfortable and durable. Sold by the dozen pair.

One size fits all.



TARPS



ALL-SEASON CONSTRUCTION QUALITY, MULTI-PURPOSE TARPS

- 8x8 weave
- 4 spare ropes
- double reinforced corners
- waterproof + rot-proof
- rope reinforced hems
- grommets every 3 ft
- 90 grams/sq meter

- #701** 6FT X 8FT
- #702** 8FT X 10FT
- #703** 9FT X 12FT
- #704** 10FT X 15FT
- #705** 12FT X 18FT
- #706** 15FT X 20FT
- #707** 18FT X 24FT
- #708** 20FT X 30FT
- #709** 24FT X 40FT
- #710** 30FT X 50 FT
- #711** 40FT X 60FT

RETAINING WALL & STAIR LIGHTS

ALL KITS

Voltage: 12V AC/DC
Beam Degree: 120°
Housing: Stainless Steel
Dimensions: 6-7/8" x 3-3/4" x 1/2"
Pigtail Length: 54"

Wattage: 2W
Color Temp: Warm White - 2700K
Lumen Output: 180 Lumens
Number of LEDs: 6 SMD



- Outdoor Lighting
- Plug and Play Wiring - ends can be clipped off to use with a HARDWIRE system
- Excellent for hardscape applications
- Ideal for adding light to any outdoor application
- Low power consumption - 2W
- High Brightness SMD chip technology
- cETLus Listed
- With waterproof connector/plug - IP67
- Dimmable (when used with a dimmable transformer)
- LED light strip is detachable and replaceable
- **Available Trim Colors: Black and Grey and Black Swivel**

120° Rotation of Swivel Light

Direct your light output where you need it to focus



These lights are also available with a swivel light strip

Hardscape Retaining Wall Light LED

#EZWL2-BLK

#EZWL2-GREY

#EZWL2-BLK-SWIVEL



Hardscape Retaining Wall Light 6.9"

Brown Trim
2700K Warm White

#EZWL845PP



Hardscape Retaining Wall Light LED

13.2" Brown Trim
2700K Warm White

#EZWL855PP



Hardscape Retaining Wall Light LED

13.2" Grey Trim
2700K Warm White

#EZWL866PP



Hardscape Retaining Wall Light 6.9" Grey Trim - 2700K Warm White

#EZWL836PP



LED Railing Light Strip 4" with Plug and Play Connector 2 Watts

#EZLS2

This LED light strip can be screwed directly into your railing, wall or steps. It's also the replacement strip for our retaining wall light #EZWL2.

Voltage: 12V AC/DC
Beam Degree: 120°
Pigtail Length: 54"
Wattage: 2W
Color Temp: Warm White - 2700K
Lumen Output: 180 Lumens
Number of LEDs: 6 SMD



*For more detailed information on all of our lights, including transformers, plug and play connectors, low voltage wire, etc., please go to: www.brickstopedge.com

RECESSED LIGHTS & RECESSED STAIR LIGHT

ALL KITS & LIGHTS

Voltage:	12V AC/DC	Pigtail Length:	11-3/4"
Lens:	Frosted	Wattage:	0.5W
IP Rating:	67	Lumen Output:	44
Mounting Hole Diameter:	1-1/4"	Number of LEDs:	6
Width of Bezel:	1-1/2"		

PLUG & PLAY



- Outdoor Lighting
- Plug and Play Wiring - ends can be clipped off to use with a HARDWIRE system
- Recessed Step and deck light • Accent Light
- Display and cabinet light
- Spring clips allow simple pressure fit installation
- Fully sealed for outdoor use
- Dimmable (when used with a dimmable transformer)



LED Outdoor Recessed Mini Deck/Patio Light

(Spring Fit) - Small Round Metal Trim

#EZDLR12 -

BLK/NKL/WHT

Color Temp: Warm White 2700K



LED Outdoor Recessed Mini Deck/Patio Light (Spring Fit)

Small Round Metal SCOOP Trim

#EZSC12 - BLK/NKL

Color Temp:

Warm White 2700K

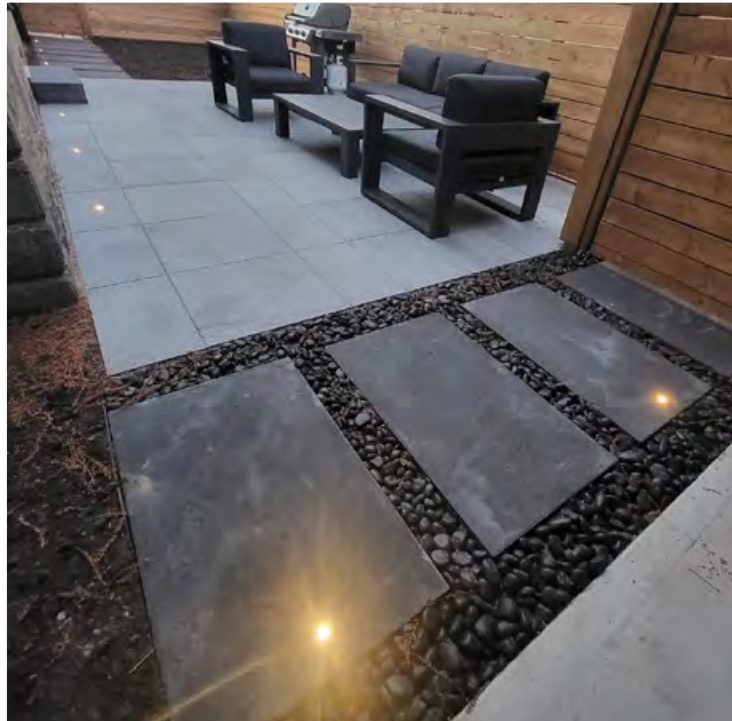

DRIVE-ON Recessed Light

#EZD13-NKL

In-ground LED light that can be driven on, used in stone or concrete. For stone, cut hole with diameter of 2". For concrete, build wire protection channel using standard PVC pipe, light fits in standard 1.5" PVC coupler.

Voltage: 12VDC

Color Temp: 3000K

Mounting Hole Diameter: 1-1/2"

Wattage: 3W

Width of Bezel: 2-1/2"

Pigtail Length: 59"

Lumens: 275

Beam Degree: 45°

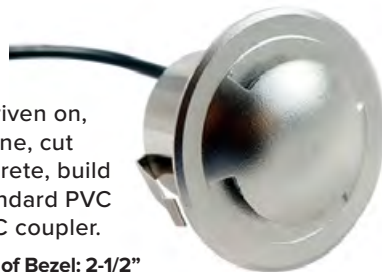

*For more detailed information on all of our lights, including transformers, plug and play connectors, low voltage wire, etc., please go to: www.brickstopedge.com

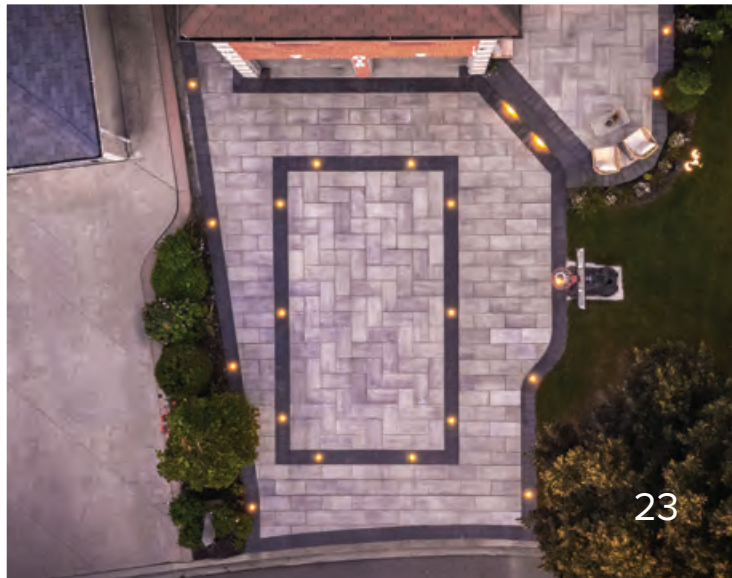

RECESSED LIGHTS



LED Outdoor Recessed Mini Deck/Patio Light (Spring Fit)

Plastic Square Trim

#EZDLS12 – BLK/NKL

Color Temp: Warm White 2700K

#EZDLS12-SS-BLK

*Black available in Stainless Steel



LED Outdoor Step, Deck and Inground Light 1 Watt

#EZIL9-NKL

Color Temp: Warm White 2700K

- Outdoor Lighting
- Plug and Play Wiring - ends can be clipped off to use with a HARDWIRE system
- Deck and step light
- Inground landscape light
- With waterproof connector/plug
- Dimmable (when used with a dimmable transformer)
- **Width of Bezel: 2-3/4"**

Voltage: 12V AC/DC
 IP Rating: 67
 Mounting Hole Diameter 1-3/4"
 Width of Bezel: 2-3/4"
 Pigtail Length: 11-3/4"
 Wattage: 1W
 Color Temp: Warm White 2700K
 Lumen Output: 260
 Number of LEDs: 1 Power



Recessed Flush Light 0.5W #EZFR35

- Trimless flush mount light
- Plug and Play Wiring - ends can be clipped off to use with a HARDWIRE system
- Applications: deck, step, plinth, patio, pavers, etc.
- White PC housing
- Fully sealed for outdoor use
- > 85 CRI

Voltage: 12V AC/DC
 IP Rating: 67
 Mounting Hole Dia: 1"
 Housing Height: 11/16"
 Pigtail Length: 12"
 Wattage: 0.5W
 Lumen Output: 38
 Number of LEDs: 1
 Color Temperature: 2700 K

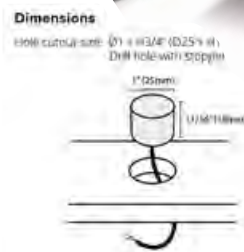

*For more detailed information on all of our lights, including transformers, plug and play connectors, low voltage wire, etc. please go to:

www.brickstopedge.com

LIMITED WARRANTY

All LEDeZe products come with a warranty. Our warranty applies against all defects in workmanship, assembly and materials used in the products. We'll repair or replace, at our sole discretion, any product that fails to operate due to a defect within the following time frames:
 3 years for lights and 2 years for transformers.

The warranty does not cover:

- Items which have become damaged due to mishandling, improper installation or use, or resulting from extreme acts of nature.
- Product finish which has faded, rusted, or pitted due to environmental factors.
- Service, installation, or other third party fees incurred due to the defect.

PATH LIGHTS & SPOT LIGHT



Outdoor LED L-Shaped Path Light including Stake – 3W #EZL3

- Metal Stake Included
- Applications: Path, Garden and Landscape
- Simple to install
- Low power consumption
- Waterproof
- Plug and Play Wiring (can be used with a hardwire system simply by clipping off the connector)
- Dimmable (when used with a dimmable transformer)

Voltage: 12V AC/DC
Pigtail Length: 59"
IP Rating: 67
Dimensions: 16" tall
Wattage: 3W
Color Temp: 3000K Warm White
Housing: Stainless Steel
Housing Color: Powder Coated Black



LED Bollard Light 3W #EZBL116

2-way splitter attached to fixture which allows for daisy chain connection (1 x 1.5 ft for main cable & 2 x 3 ft with male and female connector). Metal stake included.

Voltage: 12V DC
IP Rating: 65
Dimensions: 15" Tall
Color temp: Warm White (2700K-3000K)
Beam Degree: 165°



LED Modern Bollard Light 10W #EZBL111

2-way splitter attached to fixture which allows for daisy chain connection (1 x 1.5 ft for main cable & 2 x 3 ft with male and female connector)

Metal stake included

Voltage: 12V DC
IP Rating: 65
Dimensions: 18" Tall
Color temp: Warm White (2700K-3000K)
Beam Degree: 360°
Lumen Output: 500

Outdoor LED Garden Spotlight/Uplight including Stake – 6W #EZUL6

- Applications: Architectural, Landscape, Accent, Signage
- Innovative solid state COB LED technology
- Simple to install
- Non-Dimmable
- Low power consumption
- HARDWIRE Wiring

Voltage: 12V AC/DC
Pigtail Length: 36"
IP Rating: 67
Dimensions: 3.54 x 2.36"
Wattage: 6W
Color Temp: 3000K Warm White
Lumen Output: 480
Beam Degree: 45°



*For more detailed information on all of our lights, including transformers, plug and play connectors, low voltage wire, etc. please go to: www.brickstopedge.com



LANDSCAPE PRODUCTS

**BRICKSTOP PAVER EDGINGS
HAVE BEEN SPECIFIED AND INSTALLED IN
MANY PRESTIGIOUS LOCATIONS,
INCLUDING:**

The Korean War Memorial
Riverbanks Zoo, Columbia, SC
Wyeth-Ayerst Pharmaceuticals
City of Stockton, CA
University of Toronto
The Aquarium of Bermuda
University of California, Davis Campus
American General Insurance
Stanford University
Paramount Canada's Wonderland
Gillette Stadium, Foxboro, MA
HQ: Make a Wish Foundation of N. TX
Top-of-the-World-Way, Greenbrook, NJ
The Official Residence of the archbishop of the Czech Republic
Essex County 911 Memorial, Eagle Rock Reservation, NJ

...and thousands more.

WWW.BRICKSTOPEDGE.COM